

1. Brief

The FX5320 is a compact size embedded system with Intel Atom N270 processor board inside. This user's quick reference provides the I/O outlets description and their pin assignment.

2. Dimensions (in mm) and Front/Rear Panel Information

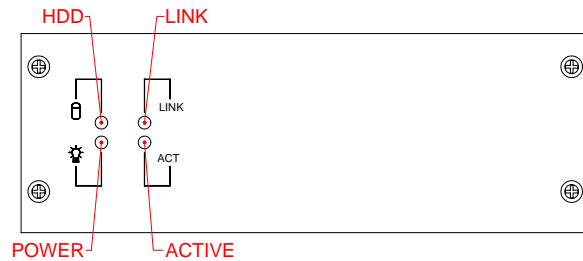
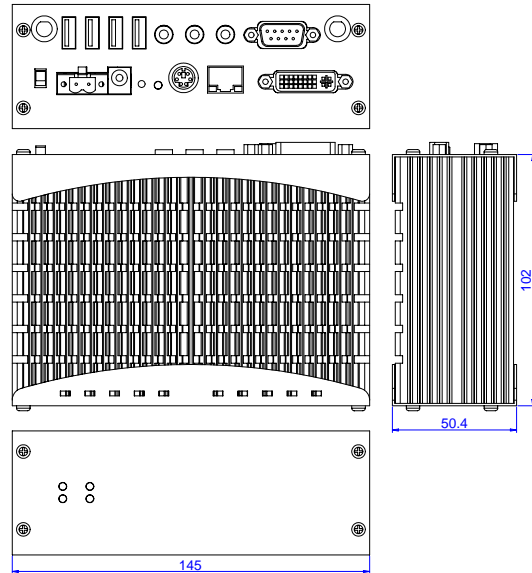

Front Panel

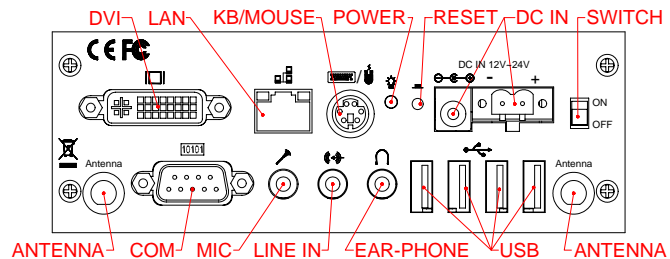

Rear Panel

3. Packing List

- 1 FX5320 embedded system.
- 1 AC-DC adapter with power code cable.
- 1 2.5" SATA hard disk installation kit with 6 screws.
- 1 DVI to CRT adapter kit.
- 1 2-pin apartable terminal block.
- 1 compact disc includes software utilities and manuals.

4. Features

- * **Processor Board**
Intel Atom N270 1.6GHz low power processor with 1GB DDR2 RAM.
- * **I/O Outlets**
One 10/100/1000 base-TX Ethernet port.
4 USB ports, 1 RS232 serial port.
1 VGA interface and 3 Audio connectors (1 Earphone, 1 Line-In, and 1 Microphone).
1 DC-Jack and 1 terminal block for DC power input.
1 power LED, 1 HDD/CF access LED, and 2 LAN LEDs.
1 mini-Card socket (w/SIM socket) for 2G/3G or wireless modules.
1 Push button reset switch.
- * **Storage Bay**
1 CompactFlash socket for CompactFlash modules or MicroDrives.
One 2.5" SATA hard disk space.
- * **Power requirement**
+12 ~ +24V DC, 1.65A maximum (0.86A typical) with DC 19V input.
- * **Dimensions**
102.0mm(D) x 145mm(W) x 50.4mm(H)

5. More Informations for I/O outlets and LED Indicators

A. Power Connectors

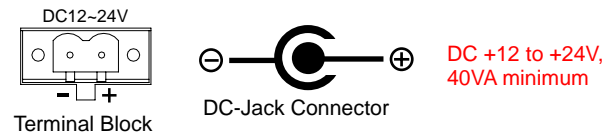

B. Keyboard/Mouse Connector

Standard PS/2 keyboard can be plugged into this connector without any adapter cable. If PS/2 keyboard and mouse will be used simultaneously, the optional Y-type adapter cable is needed.

C. LAN LED Indicator (RJ45)

The LAN port is a RJ45 connector with 2 LEDs. The orange LED indicates data is accessing and the green LED indicates on-line status.

6. Software Configuration and Driver Installation

Please refer to the driver installing documentation in the included Compact Disc for installing what device driver you need. If you need to change the system settings or configurations of I/O ports, Please refer to User's Manual (also in the included Compact Disc) for details.

7. Installing the Wall-Mount Kit (FX5311K1, optional) on FX5320

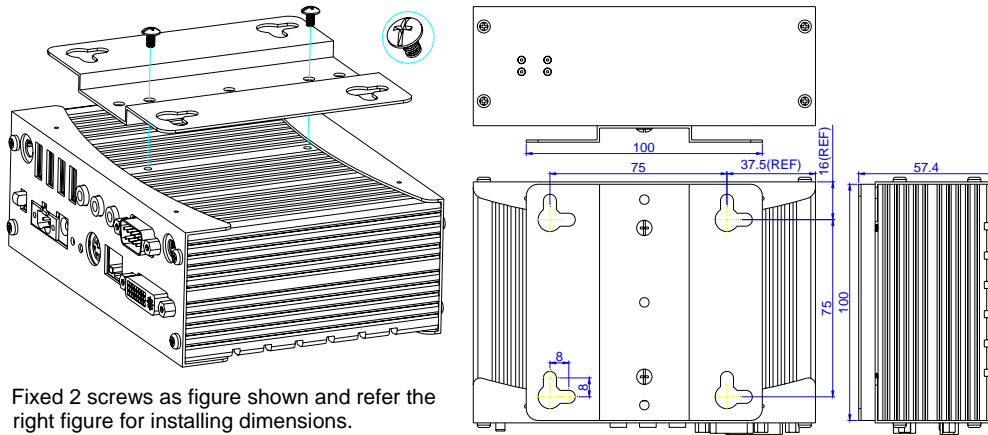

8. Installing CompactFlash into FX5320

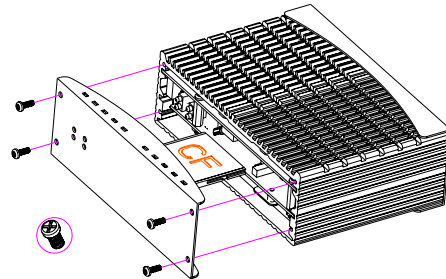

9. Installing/Changing SATA Hard Disk, DDR2 RAM Module, and mini-Card module w/SIM on FX5320

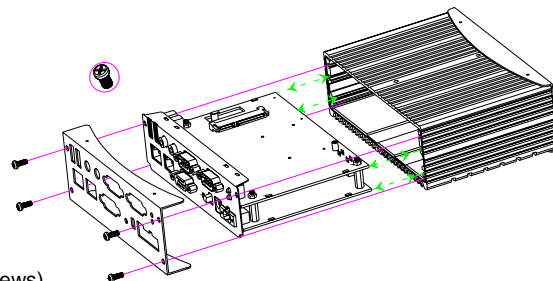

Step 1: Open the outer rear panel (4 screws)

Step 2: Open the inner rear panel (4 hexagon screws)

Step 3: Separate the main board with daughter board. (3 screws)

Step 4: Installing the DDR2 RAM Module

Step 5: Installing SIM card if necessary.

Step 6: Installing mini-card module and fix it well. (2 screws)

Step 7: Installing the Antenna(s).

Step 9: Installing SATA HDD with HDD kit (4+2 screws)

Step 8: Combine the main board and daughter board.

Step 10: Close case with reverse procedures of open the case.

End of Document