

1. Brief

The FP8150x is a 15-inch Panel PC with touch screen device (FP8150T). This user's quick reference provides its outlook information and I/O outlets description.

2. Dimensions (in mm) and Rear I/O Information

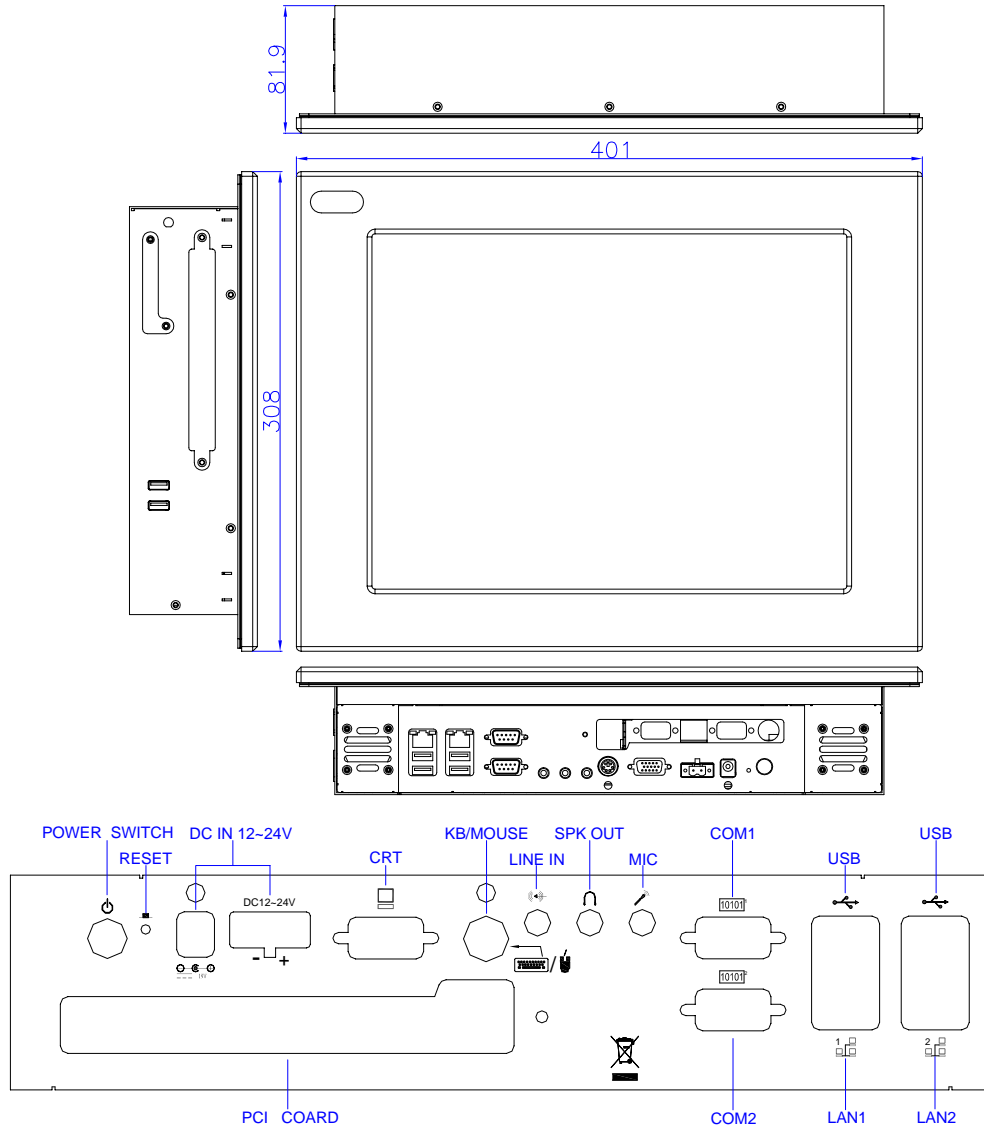

3. Packing List

- 1 FP8150x industrial Panel PC.
- 1 AC to DC19V power adapter and 1 AC power code cable.
- 1 Y-type (3-end) PS/2 keyboard plus mouse port adapter cable.
- 1 pack of wall mount kit with 12 fixed screws
- 1 pack of embedded wall mount with 5 screws
- 1 pack of 2.5" SATA HDD installing kit with screws.
- 1 touch pen for touch screen (FP8150T only)
- 1 Slim Combo DVD-ROM with screws. (Optional)
- 1 Compact Disc including user's manual and touch screen drivers.

4. Features

- * **Processor Board**
Intel low power Celeron-M processor with 1GB DDR2 RAM. (4GB Max.)
- * **I/O Outlets**
One 10/100 and one 10/100/1000 base-TX Ethernet ports.
6 USB ports (V2.0) and 2 RS-232 serial ports.
1 VGA (CRT) and 1 PS/2 compatible keyboard/mouse interface.
3 Audio connectors for line-in, Earphone, and Microphone.
Build-in 2 speakers for 2-way Audio sound output.
1 mini-PCI socket for mini-PCI I/O modules, especially for WLAN modules.
1 free PCI slot for PCI I/O Cards.
1 DC-In plug connector and 1 terminal block for DC power input.
1 power button and 1 reset button.
- * **Storage Bay**
1 CompactFlash socket for CompactFlash modules or MicroDrives.
One 2.5" hard disk space.
1 slim DVD-ROM space.
- * **Power requirement**
+11V DC (6.8A) ~ +28V DC (2.7A) with full loading.
- * **Mechanical**
Dimensions: 82mm(D) x 401mm(W) x 308mm(H)
Weight: 5.9Kg.(without HDD and slim DVD-ROM)
Approval: IP65/NEMA 4 Compliant.

5. I/O outlets and LED Indicator

A. Power Connectors

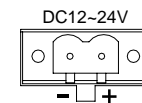

Terminal Block

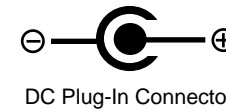

DC Plug-In Connector

DC +11V to +28V, 75W minimum



B. CRT and Audio Connectors

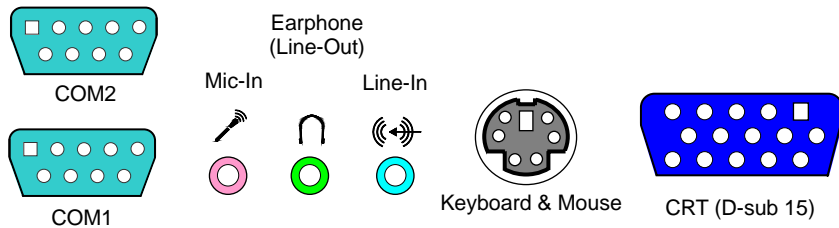

Note that standard PS/2 keyboard can be plugged into this connector without any adapter cable. If PS/2 keyboard and mouse will be used simultaneously, the included Y-type adapter cable is needed.

C. USB/LAN Connectors and LED Indicators (RJ45)

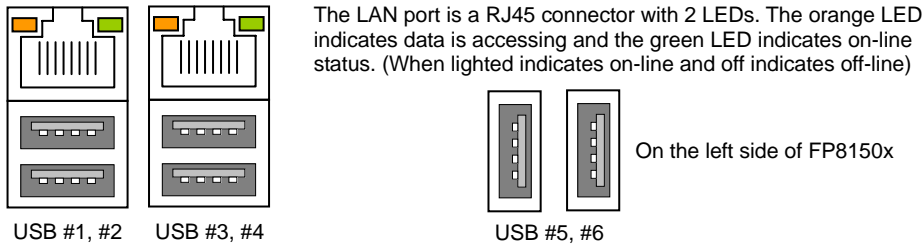

6. Installation

A. Embedded Wall Mounting and Mounting Dimensions

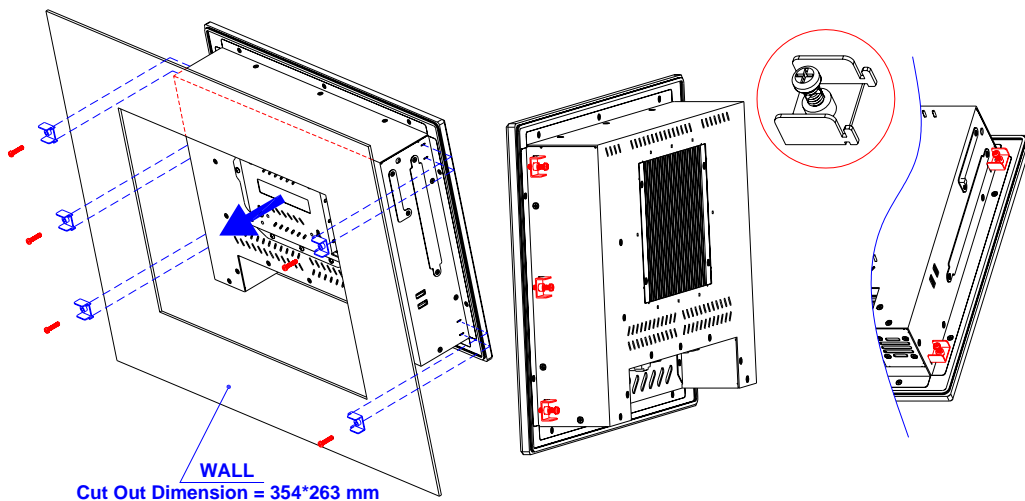

B. Standard Wall Mounting and Mounting Dimensions

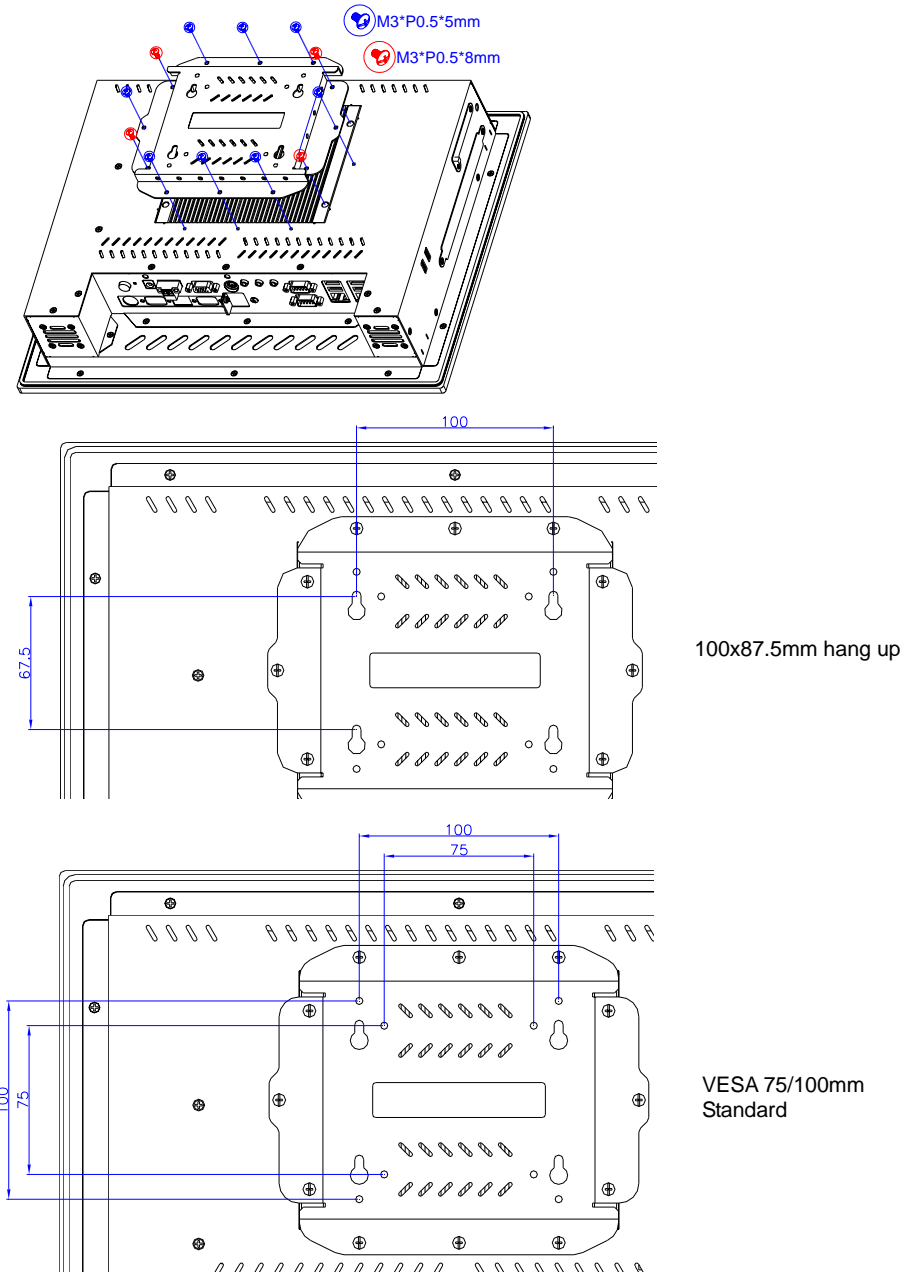

C. Installing CompactFlash and 2.5" Hard Disk

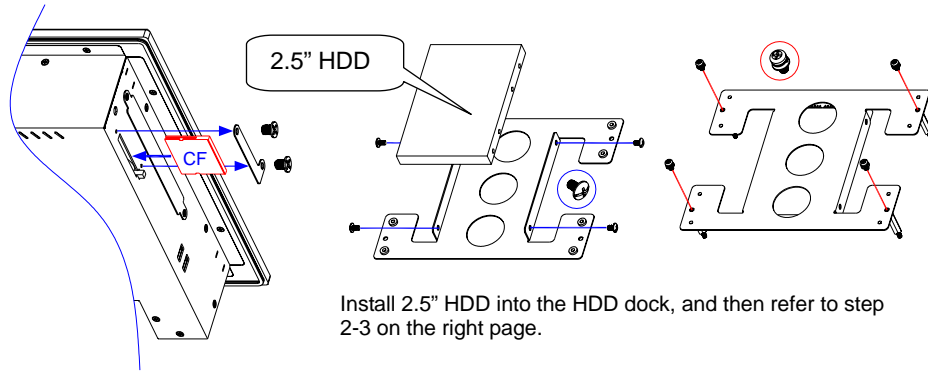

D. Installing DDR2 Module, mini PCI Module, and PCI Add-on Cards

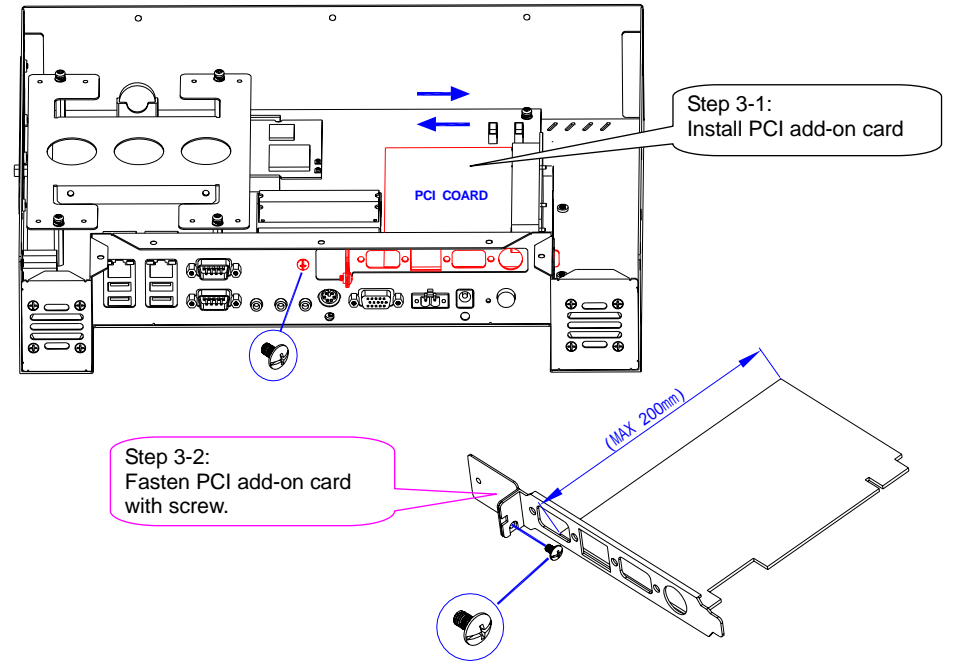
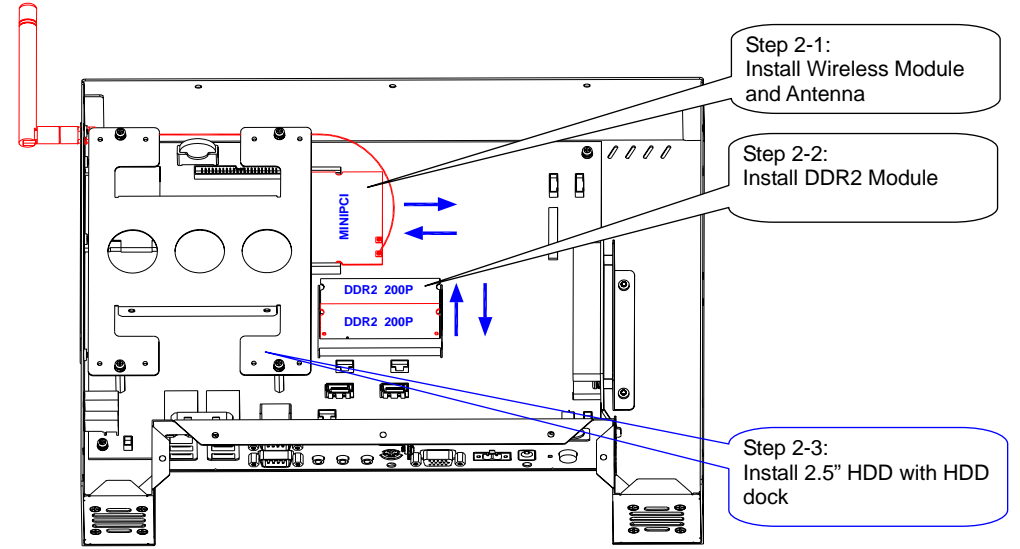
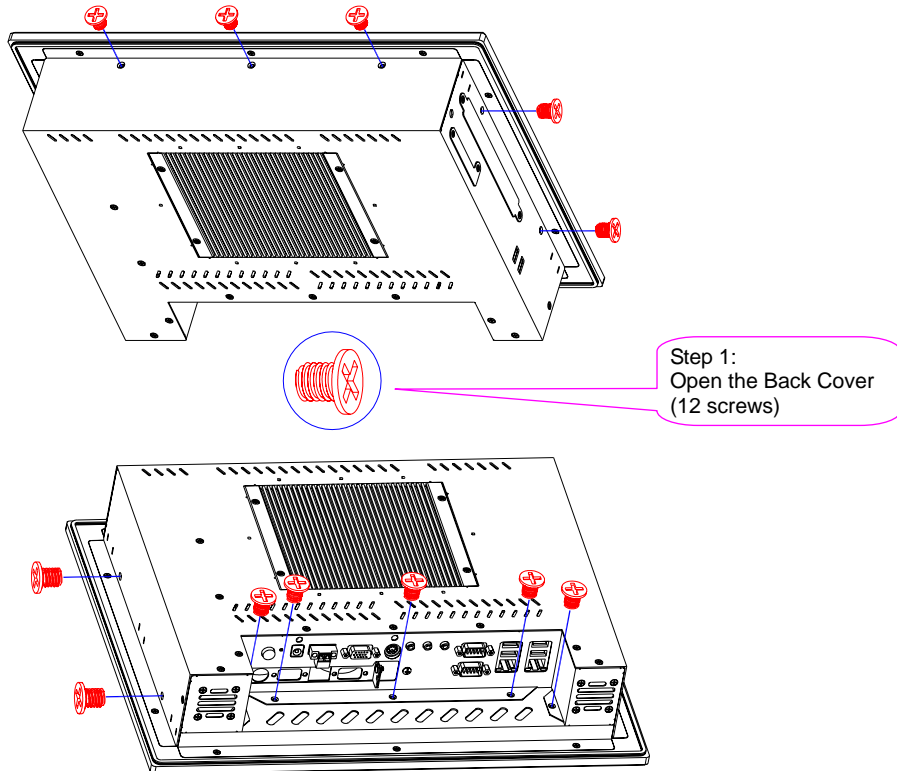

End of Document