

FabiaTech Corporation

IPC Solution

Website: <http://www.fabiatech.com>

Email: [support@fabiatech.com](mailto:support@fabiatech.com)

**Small Cube System**  
**Fanless Series**  
**FX5326 User's Manual**

---

MAY 2016  
Version: 1.2  
Part Number: FX5326

## Copyright

Copyright © 2013 FabiaTech Corporation, The content of this publication may not be reproduced in any part or as a whole, transcribed, stored in a retrieval system, translated into any language, or transcribed in any form or by any means, electronic, mechanical, and magnetic... or otherwise without the prior written permission of FabiaTech Corporation.

## Disclaimer

FabiaTech makes no representation of warranties with respect to the contents of this publication. In an effort to continuously improve the product and add features, FabiaTech reserves the right to revise the publication or change specifications contained in it from time to time without prior notice of any kind from time to time.

FabiaTech shall not be reliable for technical or editorial errors or omissions, which may occur in this document. FabiaTech shall not be reliable for any indirect, special, incidental or consequential damages resulting from the furnishing, performance, or use of this document.

## Trademarks

Trademarks, brand names and products names mentioned in this publication are used for identification purpose only and are the properties of their respective owners.

## Technical Support

If you have problems or difficulties in using the system or setting up the relevant devices, and software that are not explained in this manual, please contact our service engineer for service, or send email to [support@fabiatech.com](mailto:support@fabiatech.com).

## Returning Your Board for Service & Technical Support

If your board requires servicing, contact the dealer from whom you purchased the product for service information. You can help assure efficient servicing of your product by following these guidelines:

- ❑ A list of your name, address, telephone, facsimile number, or email address where you may be reached during the day
- ❑ Description of you peripheral attachments
- ❑ Description of your software (operating system, version, application software, etc.) and BIOS configuration
- ❑ Description of the symptoms (Extract wording any message)

For updated BIOS, drivers, manuals, or product information, please visit us at [www.fabiatech.com](http://www.fabiatech.com).

# Table of Contents

<b>FX5326 User's Manual</b> .....	<b>i</b>
<b>Chapter 1 Introducing the FX5326 System</b> .....	<b>1</b>
Overview.....	1
Series Comparison Table .....	2
Layout.....	3
Specifications.....	4
Packing List .....	5
<b>Chapter 2 Hardware Installation</b> .....	<b>7</b>
Before Installation .....	7
Removing Covers –Installing Hardware.....	8
I/O Peripheral Connectors .....	13
Connecting the DC Power and Power Switch .....	17
Power and HDD LED Indicator.....	17
Switch and Jumper Setting .....	18
<b>Chapter 3 BIOS Setup</b> .....	<b>21</b>
Overview.....	21
BIOS Functions .....	22
Keyboard Convention .....	23
Main Setup .....	24
Advanced Setup .....	25
ACPI settings.....	26
CPU Configuration.....	27
USB Configuration .....	29
Intel Fast Flash Standby.....	31
IDE Configuration.....	32
Super IO Configuration .....	34
H/W Monitor.....	37
Chipset.....	38
Host Bridge .....	39
South Bridge.....	41
Boot .....	48

Security.....	51
Save & Exit .....	53
<b>Chapter 4 Software Installation .....</b>	<b>55</b>
System Driver .....	55
WIN XP/7 Driver.....	55
VGA Driver.....	56
WIN XP/7 Driver.....	56
Audio Driver.....	56
WIN XP/7 Driver.....	56
LAN Driver (RTL 8111F) .....	57
WIN XP/7 Driver.....	57
BIOS Flash Utility.....	57
iFFS setup procedure .....	58
Watchdog Timer .....	61
Watchdog Timer Setting .....	62
Watchdog Timer Enabled .....	63
Watchdog Timer Trigger .....	64
Watchdog Timer Disabled.....	64
Digital I/O programming .....	65
CANBUS.....	66
Defined Memory Mapping And Interrupt .....	66
Example Programming .....	67
<b>Chapter 5 Technical Reference .....</b>	<b>69</b>
Trouble Shooting for Post Beep and Error Messages.....	69
Technical Reference.....	72
Physical and Environmental.....	72
Serial Ports .....	73
<b>Appendix.....</b>	<b>77</b>
Dimension .....	77



## Chapter 1 Introducing the FX5326 System

### Overview

The FX5326 is an embedded system with Intel® Atom™ N2600 low-power CPU module inside. This user's manual provides information on the physical features, installation, and BIOS setup of the FX5326.

Built to unleash the total potential of the Intel® Atom™ N2600 Processor, Able to support 1.6 GHz CPU, this unit supports two 10/100/1000 Base -TX LAN ports, four USB ports, 2-In/2-Out digital I/O, 1 So-DIMM socket supports up to 2GB DDR3 RAM , and a VGA controller.

Each FX5326 has two ports for I/O communications. One RS232/RS422/RS485 port and one RS232/RS422/RS485/CAN port are available. The CAN (Controller Area Network) is a serial bus system especially suited for networking "intelligent" I/O devices as well as sensors and actuators within a machine or plant. Characterized by its multi-master protocol, real-time capability, error correction, high noise immunity, and the existence of many different silicon components, the CAN serial bus system, originally developed by Bosch for use in automobiles, is increasingly being used in industrial automation.

The FX5326 is perfect for ATM machines, KIOSK, point-of-sales/point-of- information, gaming and infotainment, measurement technology, lotteries, and banking and small Embedded Control. The unit is only 102 mm (D) X50.4 mm (W) X145 mm (H).

## Series Comparison Table

Model	FX5326
System Processor	Intel® Atom™ N2600 1.6GHZ
<i>S-Chipset</i>	<i>NM10</i>
<i>Memory</i> <i>204 Pin-DIMM*1</i>	<i>DDR3-800/1066</i> <i>2GB</i>
<i>Storage</i>	<i>One CFast, SD and</i> <i>One 2.5' SATA HDD</i>
<i>Display</i>	<i>VGA/CRT</i>
<i>Watchdog Timer</i>	<i>Yes</i>
<i>Multi I/O</i>	<i>One RS232/RS422/RS485 and</i> <i>One RS232/RS422/RS485/CAN</i>
<i>USB 2.0</i>	<i>Four</i>
<i>Audio</i>	<i>Ear-Phone</i>
<i>RJ45 LAN port</i> <i>(10/100/1000 Mbps)</i>	<i>Two Realtek RTL8111F</i>
<i>PCIe Mini Card</i>	<i>One</i>
Operating Temperature	0~+ 50°C (32~122°F)
Storage Temperature	-20~+60°C (4~140°F)
Dimensions (Unit: mm)	50.4(W) x 102 (D) X 145 (H)

## Layout

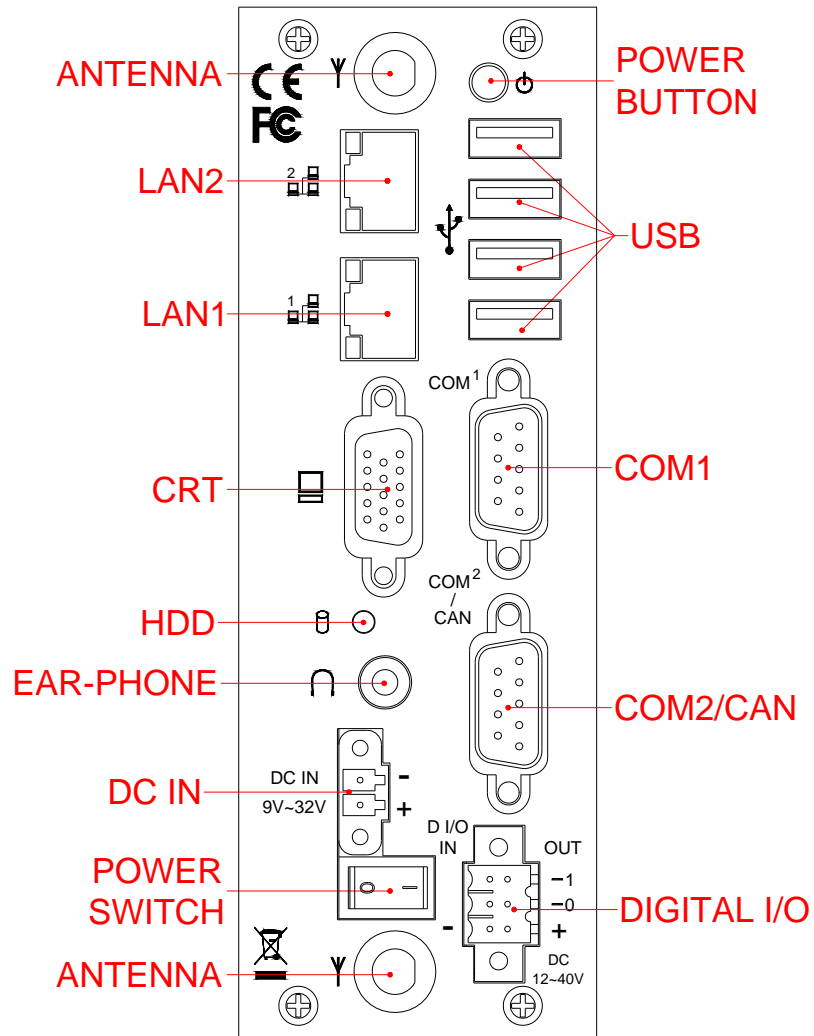



## Specifications

### ❑ ***Processor Board –***

Intel ® Atom™ N2600 1.6GHZ Low Power Processor with 2GB DDR3-RAM.

### ❑ ***I/O Outlets –***

Two 10/100/1000 base-TX Ethernet LAN port with RJ45.

One VGA display connector with DB15 and one Audio connector for Earphone-Out

Four USB ports (2.0) with type A connector

One RS-232/RS422/RS485 and one RS-232/RS422/RS485/CAN port with DB9

2-In and 2-Out Isolated Digital I/O with terminal block

One PCIe Mini card socket modules, especially for WLAN/GPRS module

One DC-In terminal block with power switch and power button

### ❑ ***CAN BUS –***

The CAN bus using the Philips SJA1000 controller, electrically compatible with the PCA82C200 stand-alone CAN controller chip

- Full CAN-functionality 2.0 B
- Extended receive buffer (64 byte FIFO)
- 16 MHz CAN Control frequency

### ❑ ***Storage Bay-***

CFast Compact Flash socket for CFast Compact Flash modules

One SATA 2.5" hard disk space

One SD socket supports up to 32GB SDHC (Class 6)

### ❑ ***Power requirement –***

+9 ~ +32V DC, 1.7A maximum (1.0A typical) with DC 19V input

### ❑ ***Dimensions -***

102.0mm (D) x 145.0mm (W) x 50.4mm (H)

## Packing List

Upon receiving the package, verify the following things. Should any of the mentioned happens, contact us for immediate service.

- Unpack and inspect the FX5326 package for possible damage that may occur during the delivery process.
- Verify the accessories in the package according to the packing list and see if there is anything missing or incorrect package is included.
- If the cable(s) you use to install the FX5326 is not supplied from us, please make sure the specification of the cable(s) is compatible with the FX5326 system.

**Note:** after you install the FX5326, it is recommended that you keep the diskette or CD that contains drivers and document files, and keep the document copies, or unused cables in the carton for future use.

The following lists the accessories that may be included in your FX5326 package. Some accessories are optional items that are only shipped upon order.

- One FX5326 embedded system.
- One pack of 2.5" SATA hard disk installation kit with fixed screws.
- One 2-pin apartable terminal block.
- One 2\*3-pin apartable terminal block for isolated digital I/O.
- One DIN Rail mounting kit with 2 screws.
- One compact disc includes software utility and manual.

Optional:

- One pack of half size mini PCIe module adapter kits.( P/N:0606010028G)
- FX5311K1 panel back mounting fixers and 2 screws (VESA 75\*75). (P/N:0606010019G)
- FX5321K1 2U Rack mounting kit (P/N: 0606010030G)



## Chapter 2 Hardware Installation

This chapter introduces the system connectors & jumper settings, and guides you to apply them for field application.

### Before Installation

Before you install the system, make sure you follow the following descriptions.

1. Before removing the cover, shut down the operation System and disconnect power switch to off and unplug DC-In cable.
2. Install any connector, Compact Flash, and hard disk is sure that the power is disconnected or power switch to off from the system. If not, this may damage the system.
3. The ESD (Electricity Static Discharge) may be created from human body that touches the board. It may do damage to the board circuit.

➤ **Removing Covers -Installing Hardware**

If you are installing hardware option, you can remove the front and back cover. The following figure will guide you how to install CFast modules, SD Card, 2.5" HDD inside and PCIe Mini card the FX5326 and how to install the FX5326 fixers. (Please see the spots circled.)

**a. Unscrew front cover and Installing Compact Flash & SD card**

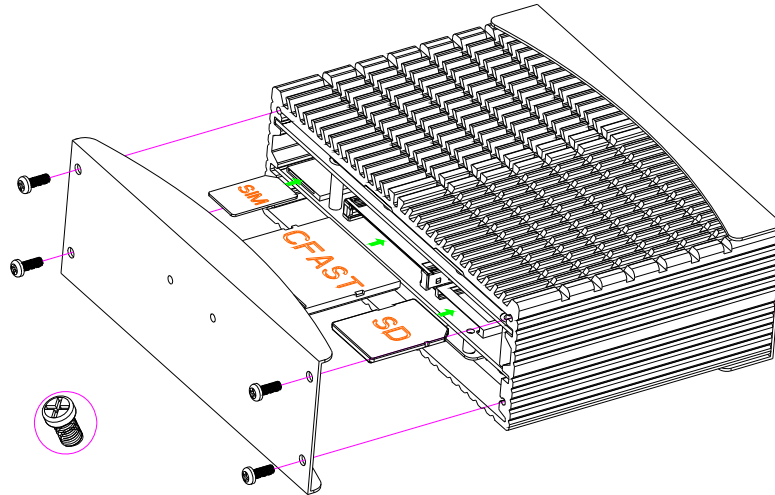

**Note:** The SD socket supports up to 32GB SDHC (Class 6).

**b. Unscrew back cover and Installing Hard Disk**

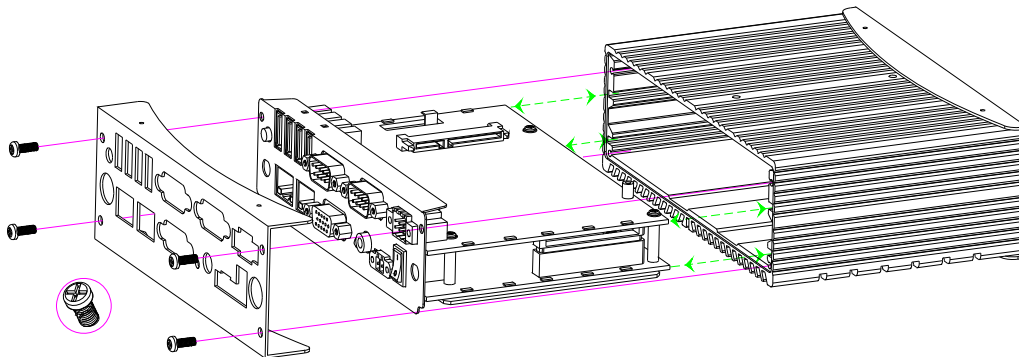

◇ **b1. Installing Hard Disk**

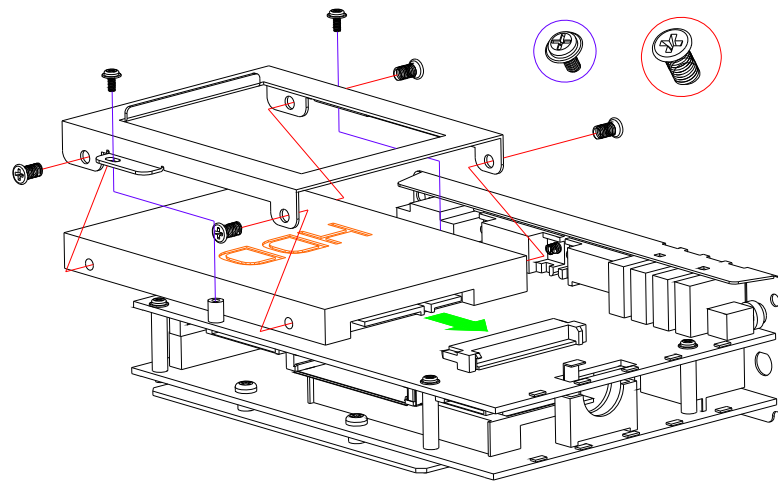

**Note:** Use caution when handling the hard disk to prevent damage to SATA connector as you inserted hard disk. Be careful with the orientation when installing connectors.

**c. Installing Memory: So-DIMM Socket for DDR3 RAM Modules**

You may extend additional memory to FX5326, See as following figure and rear pictures. The So-DIMM socket supports 1GB to 2GB of DDR3 RAM modules.

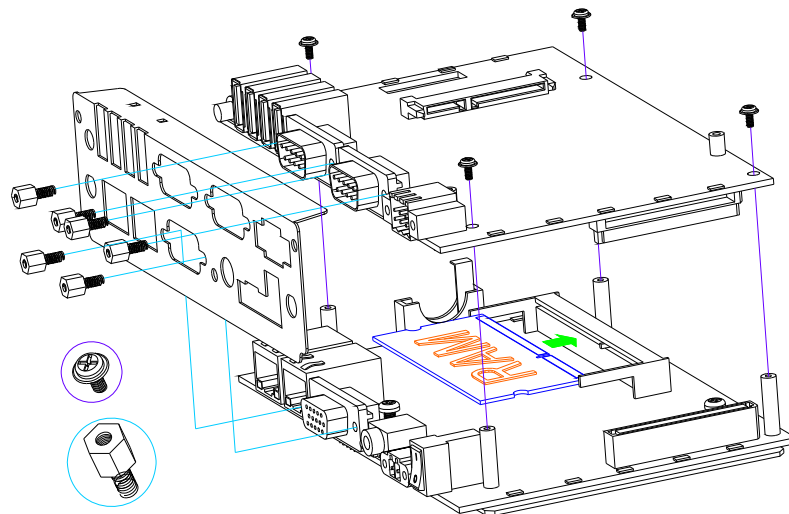

#### d. Installing PCIe Mini Card Module –Daughter Board

You may extend additional PCIe mini card module and SIM card to FX5326. Connect the antenna cable from backside antenna hole to GPRS module and installing the SIM card to SIM socket. See as following figure.

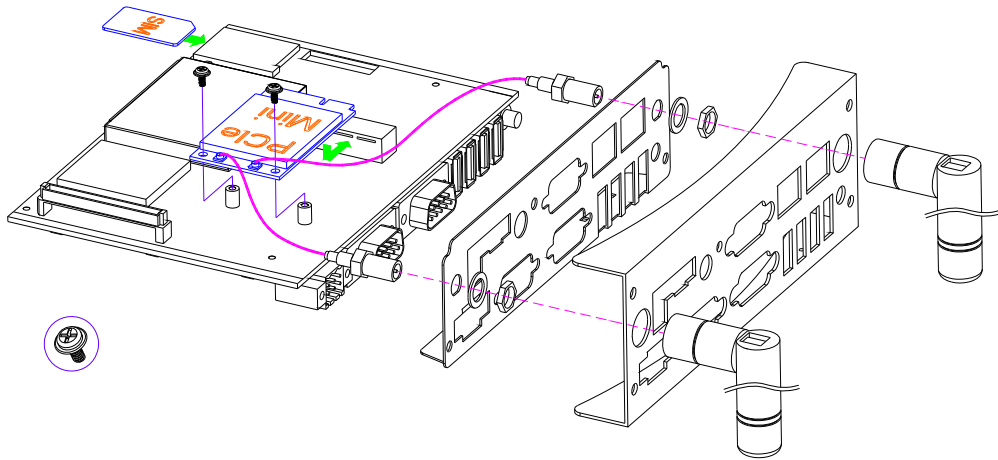

**Note:**

1. When installing PCIe GPRS Mini card on FX5326 system these is need the installing the SIM Card to daughter board of system.
2. The insert SIM card into the SIM card socket. Make sure that the SIM card is properly inserted and that golden contact area on the card is facing downwards.

#### ◇ d1. Installing Half Size Mini PCIe module kit (Optional)

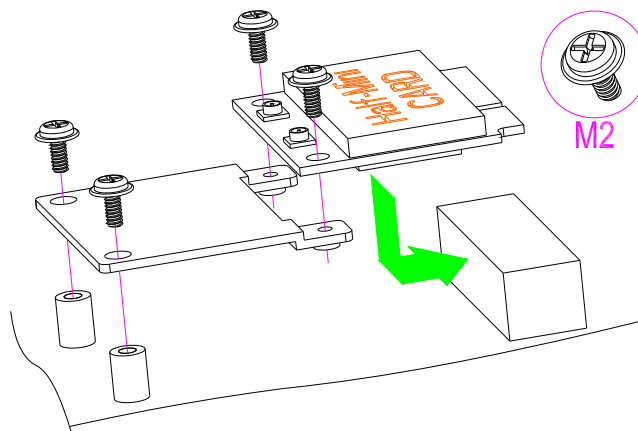

**e. Installing the DIN-Rail fixers or universal fixers on FX5326**

Please refer to the down side figure for installing the FX5326 with universal fixers.

e1. FX5326 Din-Rail

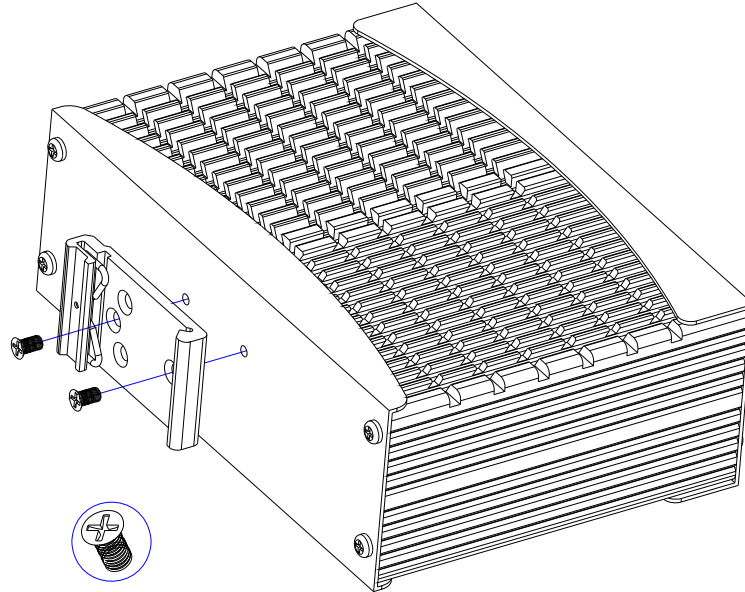

e2. FX5311K1 – Panel Back Mounting (VESA Mount 75\*75)

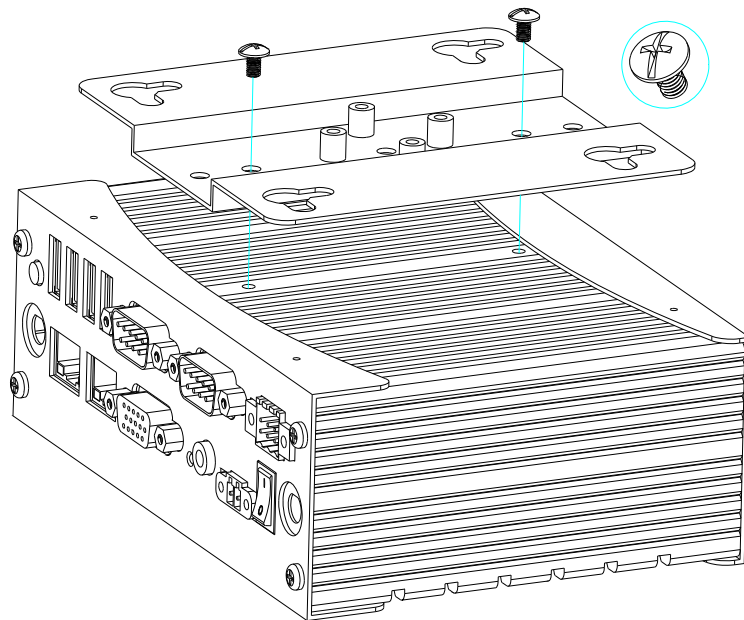



e3. FX5321K1 – 2U Rack Mount Kit

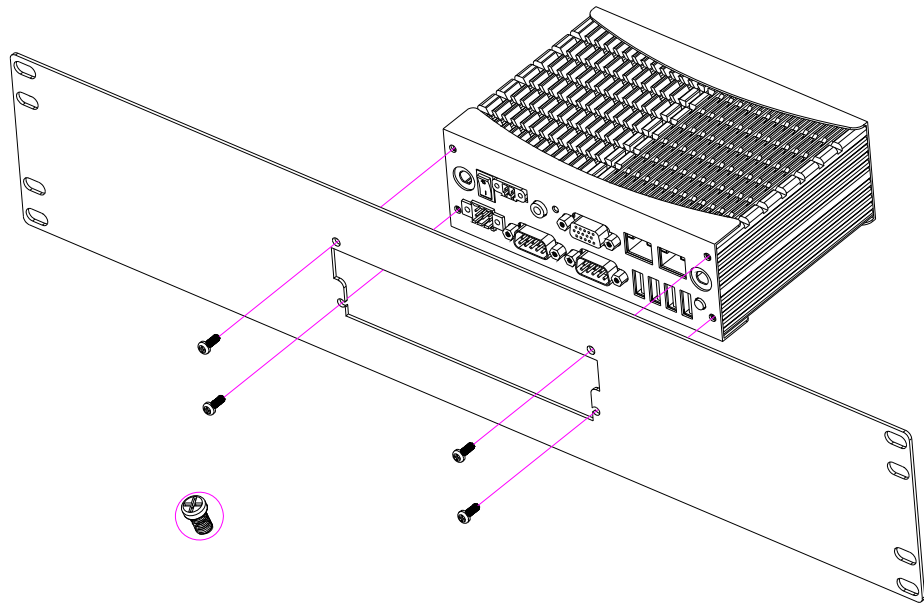

➤ **I/O Peripheral Connectors**

View from the back side, if you are connecting the monitor, LAN, COM, CAN, Audio, Digital I/O and USB to the FX5326. See following figure and a side pictures.

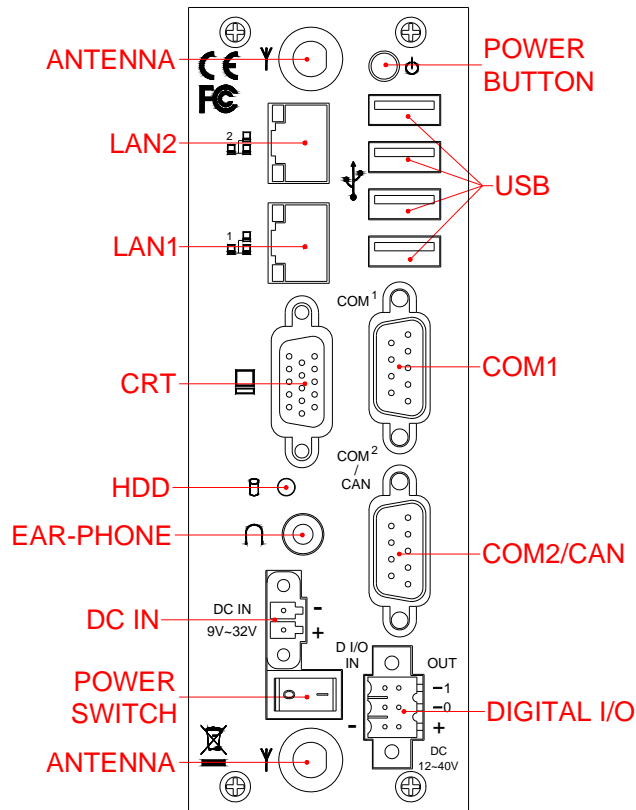

1. A VGA (CRT) connector is provided for VGA signals.

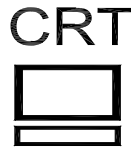
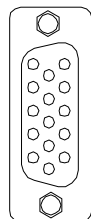

DB15	Signal
1	Red
2	Green
3	Blue
13	Hsync
14	Vsync
12	DDC Data
15	DDC Clock
5 & 10	Digital Ground
6,7,8	Analog Ground
Others	Not Used

## 2. Connecting the COM port

The COM1 and COM2 (DB9) are designed for multiple proposes, It's can select RS-232/422/485/CAN (The CAN port Only for COM2) by [BIOS](#) or [jumper setting](#). The following tables show the signal connections of these connectors.

**COM1**                      **COM2**

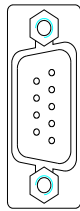

DB9	RS-232	RS-422	RS-485
1	-DCD		
6	-DSR		
2	RXD	RX-	485-
7	-RTS	TX-	
3	-TXD	RX+	485+
8	-CTS	TX+	
4	-DTR		
9	-RI/5Vor 12V		
5	Ground		
Metal	Case Ground		

## 3. Connecting the CAN-BUS

The CANBUS is use COM2 (DB9) standard connector. The following tables show the signal connections of this connector.

**CAN**

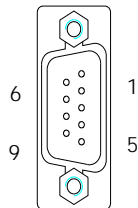

DB-9	CANBUS Signal	CANBUS Description
1	N.C	-
6	N.C	-
2	CAN-L	Dominant Low
7	CAN-H	Dominant High
3	CAN-Ground	Isolated Ground
8	N.C	-
4	N.C	-
9	N.C	-
5	Ground	Digital Ground
Case	Case Ground	

**Note:** 1. The CANBUS DB9-pin out conforms to the ISO 11898/2 standard specification.

#### 4. Connecting the LAN ports (LAN1&LAN2)

The RJ45 connector with 2 LED's for LAN. The up LED (orange) indicates data is being accessed and the down side LED (green) indicates on-line status. (On indicates on-line and off indicates off-line)

RJ45 connector

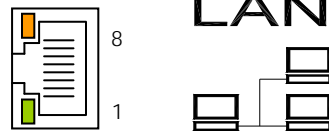

RJ45	LAN1/2	RJ45	LAN1/2
1	MDIO+	5	MDI2+
2	MDIO-	6	MDI2-
3	MDI1+	7	MDI3+
4	MDI1-	8	MDI3-

#### 5. Connecting the USB Ports

The FX5326 supports a four port USB connector. Any USB device can be attached to USB ports with plug-and-play supported.

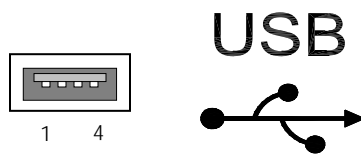

USB #1~ #4	Signal
1	USBV
2	USB D-
3	USB D+
4	USBG

#### 6. Digital I/O Connector

The FX5326 provides 2-in and 2-out isolated digital I/O, output port is an open collector, you will need connections external voltage of Digital (+) and digital (-) connector.

D I/O

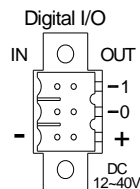

DI/O	Signal	Bit Location
IN-1	DGI1	<a href="#">Please refer to Chapter 4- Digital I/O - Software programming example</a>
IN-0	DGI0	
OUT-1	DGO1	
OUT-0	DGO0	
+	Digital Voltage	
-	Digital Ground	

**Note:** Digital inputs accept DC12~40V Signal with isolated input. Digital outputs are active-low open collector output, and can drive up to 60V/400mA maximum.

## 7. Connecting the Audio EAR-Phone



EAR-Phone

➤ **Connecting the DC Power and Power Switch**

Power is supplied through an external power DC In. See following figure and a side pictures.

1. DC Power Connector: Use external 2-pin apartable terminal block.

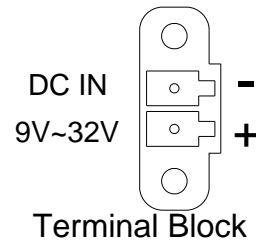
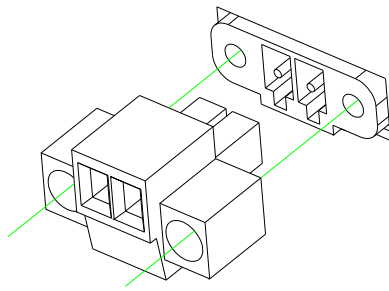

**Terminal Block**

DC +9V~+32V, 40VA  
minimum

2. Power Switch and Power Button: The Power Switch controls the main power switch, plugging DC into DC power connector then turn on the Power Switch, when you final installed system hardware device. Pushing the Power button once will switch the FX5326 on and off.

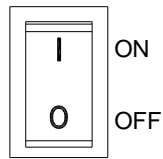

Power Switch: On/Off



Power button: On/Off

➤ **Power and HDD LED Indicator**

The Power LED is integrated into the power button. The HDD LED's has two distinctive statuses: Off for inactive operation and blinking light for activity.

POWER



HDD



➤ **Switch and Jumper Setting**

The Serial port is designed for multiple proposes, Use SW2 selects RS-232, RS-422 or RS-485 of COM1, use SW1, JP4 and JP5 selects RS-232, RS-422, RS-485 or CAN Bus of COM2 connector. SW4 is selects RS485 terminator resistor, JP3 and JP6 is to select power source with RI# pin of DB9. JP8 is used to select 3VSB/3.3V voltage with PCIe Mini Card module (See a PCIe Mini Card module specification.), JP3 is used to clear CMOS data, JP7 is the CAN bus termination jumper.

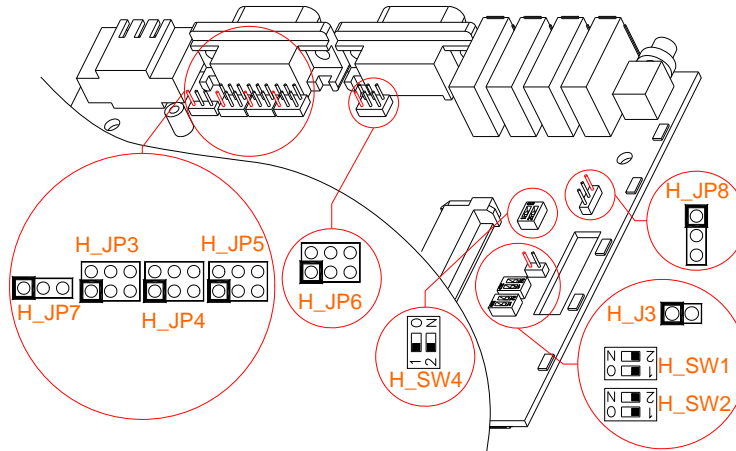

□ **SW1, SW2, SW4, JP3, JP4, JP5 and JP6: COM1 & COM2 RS232/422/485 Selection**

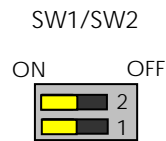

Factory Preset: BIOS Cntl.  
SW2-COM1/SW1-COM2

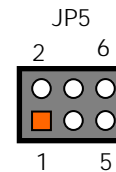
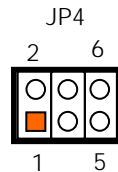

Factory Preset: COM2  
for RS232/RS422/RS485

SW1/2-1	SW1/2-2	COM1/2
Off	Off	RS-232
On	Off	RS-485
Off	On	RS-422
On	On	BIOS Cntl.

◇ **a. SW4-1 (COM1), SW4-2 (COM2): RS-485 Terminator Setting**



RS-485 Terminator Disabled  
Factory Preset

SW4



RS-485 Terminator Enabled

✧ ***b. JP3 and JP6: COM1 & COM2 Power Source Jumper Select***

The COM1 and COM2 ports provide power source will driver the "RI" signal pin if JP3 for COM2 and JP6 for COM1 were located on the power output position.

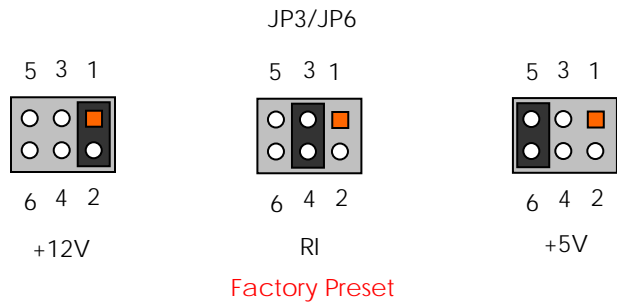

□ **JP4, JP5 and JP7: COM2 CAN Bus Selection**



✧ ***a. JP7 CAN Bus Terminal Resistor Selection***

The JP7 is the CAN bus termination jumper. Only two termination jumpers should be closed at the endpoints of the CAN bus.

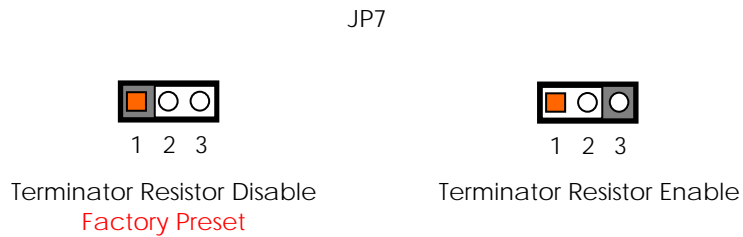



❑ **JP8: PCIe mini-Card auxiliary power source selection**

When installing the PCIe Mini Card module, if not correct working (See a PCIe module card specification pin-24 3.3VAUX.), you can to select 3VSB/3.3V voltage.

JP8

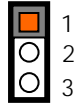

Power source Form VCC3  
Factory Preset

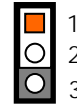

Power source Form 3VSB

❑ **J3: Clear CMOS Setting**

You can use J3 to clear CMOS data. The CMOS stores information like system date, time, boot up device, password, IRQ... which are set up with the BIOS. To clear the CMOS, set J3 to 1-2 closed and wait 3-5 sec then return to open before system powers off. The default setting is opened.

J3



1 2  
Factory Preset



1 2  
Clear CMOS Data

## Chapter 3 BIOS Setup

This chapter describes the BIOS setup.

### Overview

BIOS are a program located on a Flash memory chip on a circuit board. It is used to initialize and set up the I/O peripherals and interface cards of the system, which includes time, date, hard disk drive, the ISA bus and connected devices such as the video display, diskette drive, and the keyboard. This program will not be lost when you turn off the system.

The BIOS provides a menu-driven interface to the console subsystem. The console subsystem contains special software, called firmware that interacts directly with the hardware components and facilitates interaction between the system hardware and the operating system.

The BIOS default values ensure that the system will function at its normal capability. In the worst situation the user may have corrupted the original settings set by the manufacturer.

All the changes you make will be saved in the system RAM and will not be lost after power-off.

When you start the system, the BIOS will perform a self-diagnostics test called Power On Self Test (POST) for all the attached devices, accessories, and the system. Press the [Del] key to enter the BIOS Setup program, and then the main menu will show on the screen.

**Note:** Change the parameters when you fully understand their functions and subsequence.

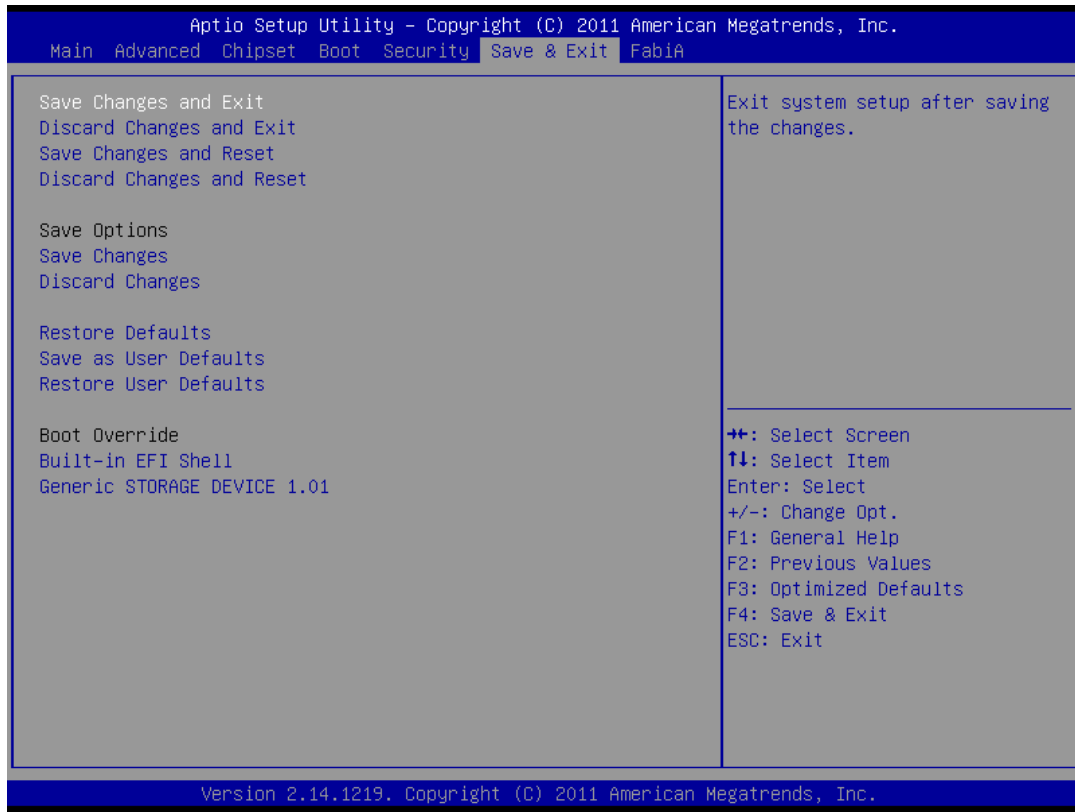

□ **BIOS Functions**

On the menu, you can perform the following functions

1. Main
2. Advanced
  - ACPI Settings
  - CPU Configuration
  - USB Configuration
  - Intel Fast Flash Standby
  - IDE Configuration
  - Super IO Configuration
  - H/W Monitor
3. Chipset
  - Host Bridge
  - South Bridge
4. Boot
  - CSM parameters
5. Security
6. Save & Exit

□ **Keyboard Convention**

On the BIOS, the following keys can be used to operate and manage the menu:

Key	Function
[↑][↓]	The Up and Down keys allow you to select item.
[←][→]	The Left and Right keys allow you to select screen.
[Enter]	The Enter key allows the user to select an option to edit its value or access a sub menu.
[+]/[-]	The Plus and Minus keys allow you to change the field value of a particular setup item.
[F1]	General Help.
[F2]	Previous Values.
[F3]	Optimized Defaults.
[F4]	Save current configuration and exit.
[ESC]	To exit the current menu or message.

## Main Setup

This section describes BIOS version information and basic system hardware configuration. If the CPU board is already installed in a working system, you will not need to select this option anymore.

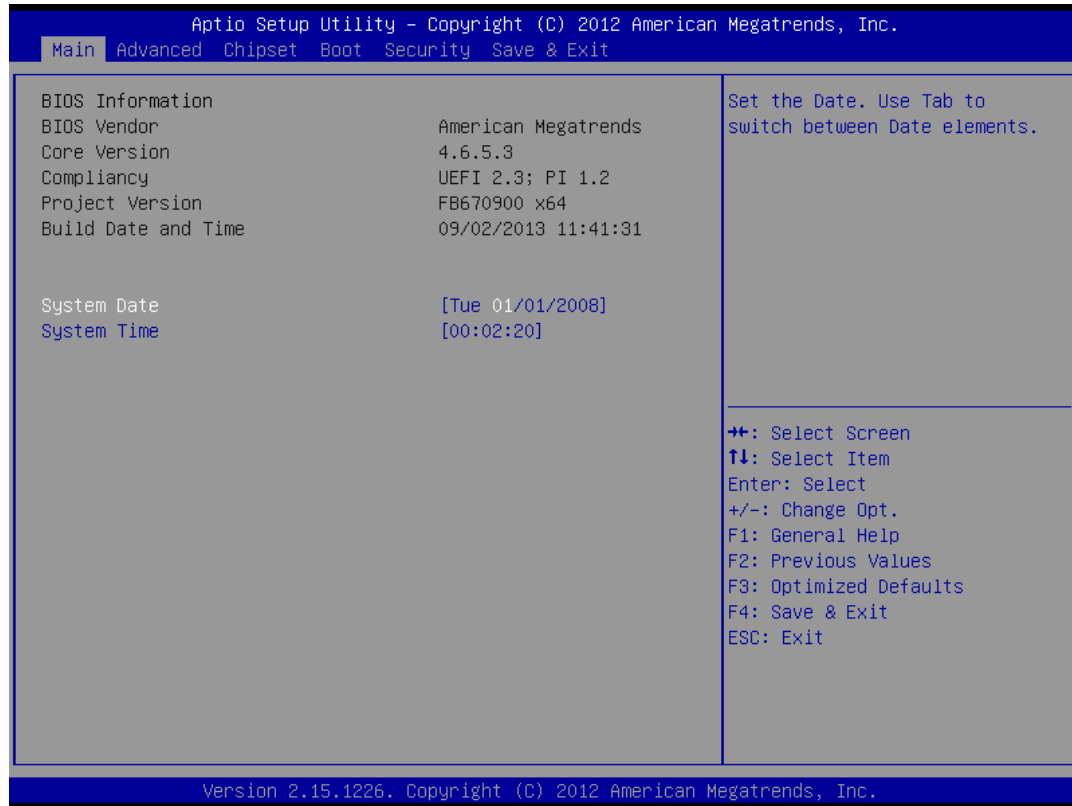

### □ System Date & Time Setup

Highlight the <Date> field and then press the [+] / [-] keys or enter new values to set the current date. Follow the month, day and year format.

Highlight the <Time> field and then press the [+] / [-] keys or enter new values to set the current date. Follow the hour, minute and second format.

The user can bypass the date and time prompts by creating an AUTOEXEC.BAT file. For information on how to create this file, please refer to the MS-DOS manual.

## Advanced Setup

Select the Advanced tab from the setup screen to enter the Advanced BIOS Setup screen. You can select any of the items in the left frame of the screen, such as USB Configuration, to go to the sub menu for that item. You can display an Advanced BIOS Setup option by highlighting it using the <Arrow> keys. All Advanced BIOS Setup options are described in this section. The Advanced BIOS Setup screen is shown below. The sub menus are described on the following pages

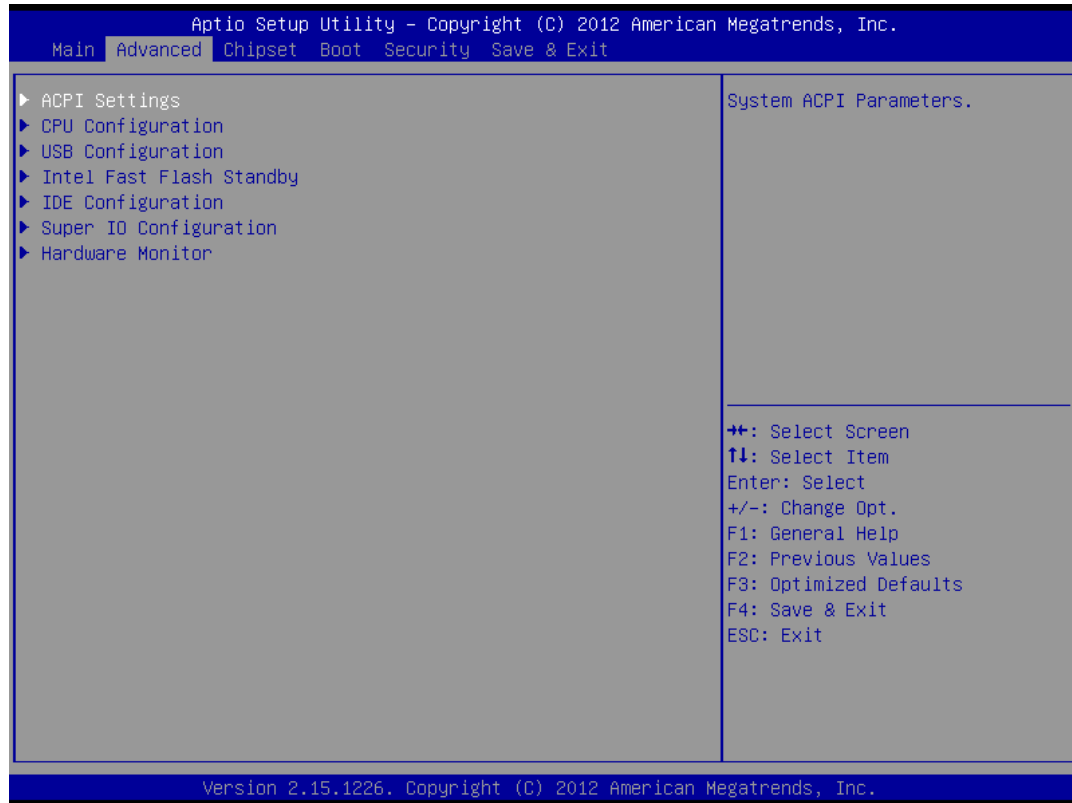

➤ **ACPI settings**

This field specifies allow you set this value to utilize the ACPI (Advanced Configuration and Power Interface) specification.

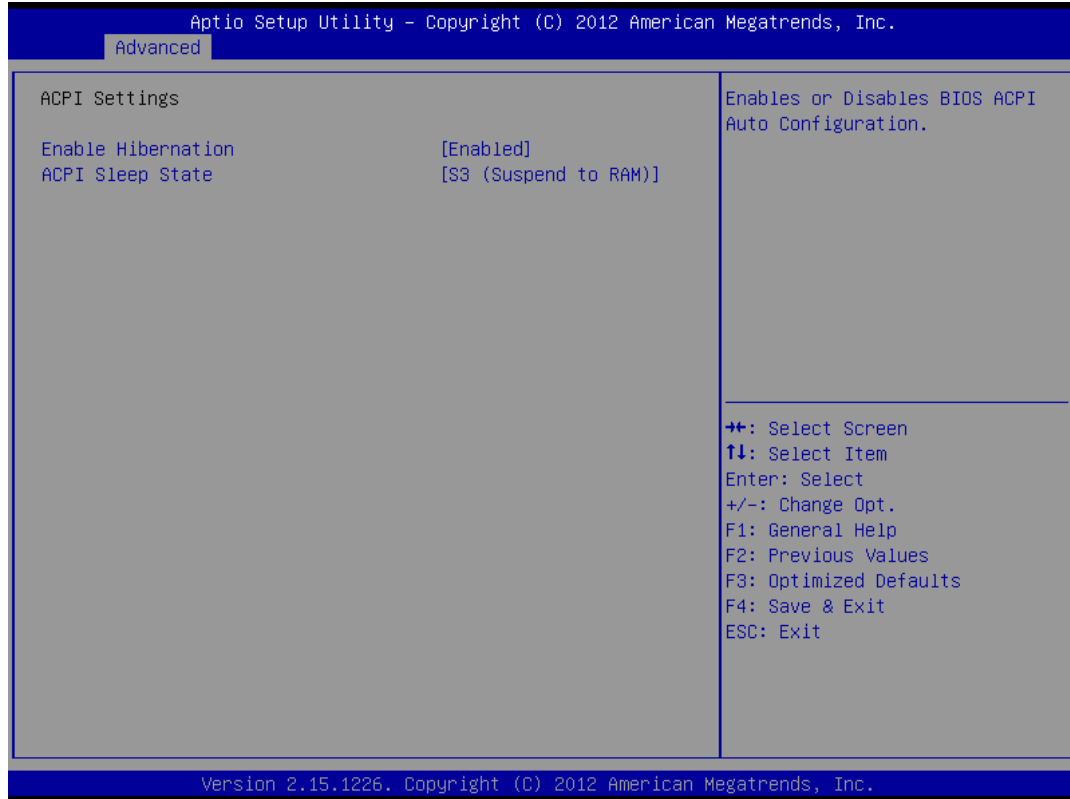

❑ **Enable Hibernation**

This item allows users to enable or disable system ability to Hibernate (OS/S4 Sleep State). This option may be not effective with some OS.

**Available Options:** Disabled, Enabled

**Default setting:** Enabled

❑ **ACPI Sleep State**

This item allows users to select the highest ACPI sleep state the system will enter when the SUSPEND button is pressed.

**Available Options:** Suspend Disabled, S1 (CPU Stop Clock), and S3 (Suspend to RAM)

**Default setting:** S3 (Suspend to RAM)

## ➤ CPU Configuration

You can use this screen to select options for the CPU information. Use the up and down <Arrow> keys to select an item. Use the <Plus> and <Minus> keys to change the value of the selected option.

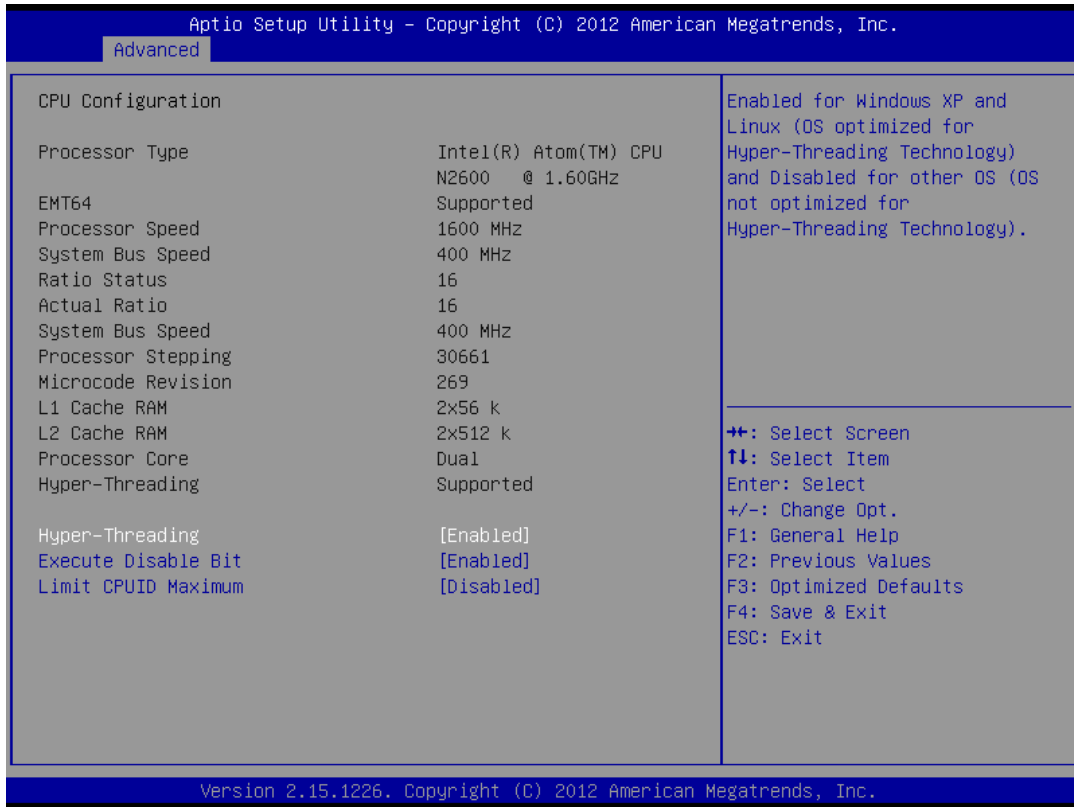

### ❑ Hyper-Threading

This field allows the users to enable or disable the Hyper Threading. Enable for Windows XP and Linux (OS optimized for Hyper-Threading Technology) and Disable for other OS (OS not optimized for Hyper-Threading Technology).

**Available Options:** Disable and Enable

**Default setting:** Enabled

### ❑ Execute Disable Bit

This field allows users to enable or disable the No-Execution page protection. XD can prevent certain classes of malicious buffer overflow attacks when combined with a supporting OS. (Windows Server 2003 SP1, Windows XP SP2, SuSE Linux 9.2, RedHat Enterprise 3 Update 3.x)



**Available Options:** Disable and Enable

**Default setting:** Enabled

**Limit CPUID Maximum**

This field allows users to enable or disable limit CPUID maximum, to disable this item when Windows XP.

**Available Options:** Disable and Enable

**Default setting:** Disable

➤ **USB Configuration**

You can use this screen to select options for the USB Configuration.

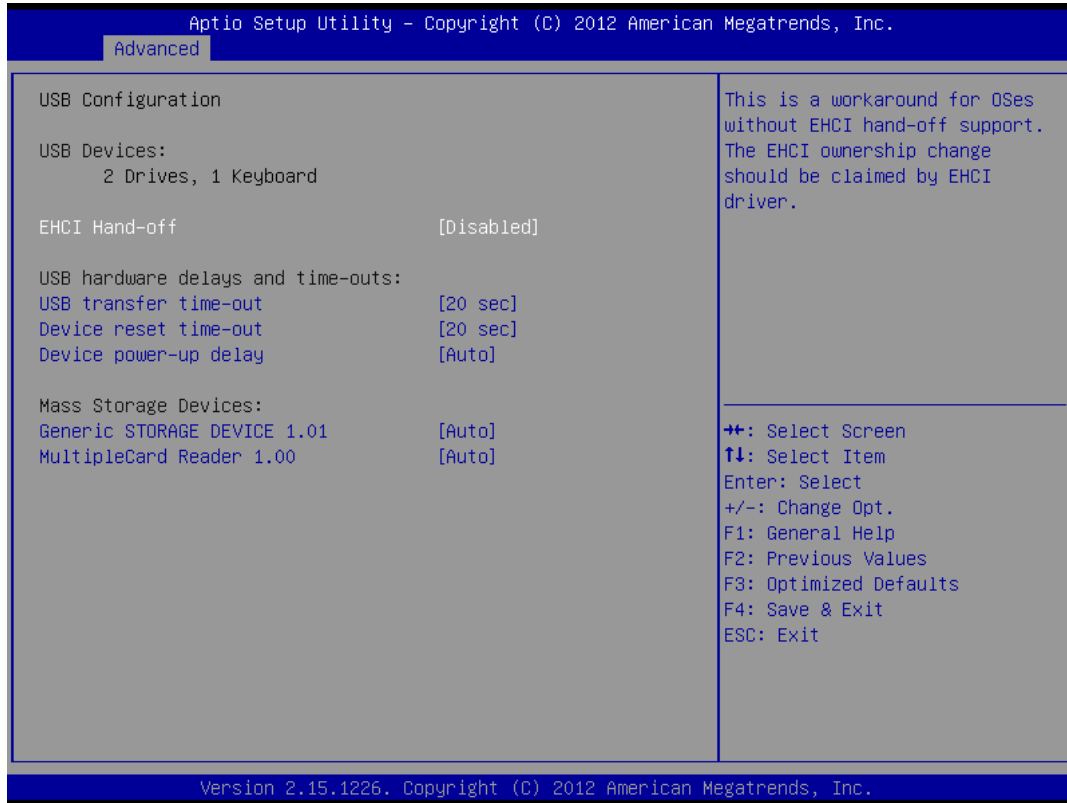

□ **EHCI Hand-Off**

This is a workaround for OS without EHCI Hand-Off support. The EHCI ownership change should claim by EHCI driver.

**Available Options:** Disabled, and Enabled

**Default setting:** Disabled

□ **USB transfer time-out**

The time-out value for control, bulk, and interrupt transfers.

**Available Options:** 1 sec, 5 sec, 10 sec, and 20 sec

**Default setting:** 20 sec

❑ **Device reset time-out**

USB mass storage device start unit command time-out.

**Available Options:** 10 sec, 20 sec, 30 sec, and 40 sec

**Default setting:** 20 sec

❑ **Device power-up delay**

Maximum time the device will take before it properly reports itself to the Host controller. 'Auto' uses default value: for a Root port it is 100 ms, for a Hub port the delay is take from Hub descriptor.

**Available Options:** Auto, and manual

**Default setting:** Auto

❑ **Mass Storage Devices:**

Mass storage device emulation type. If the emulation FDD, recommended formatted as FAT32 format.

**Available Options:** Auto, Floppy, Forced FDD, Hard Disk, and CD-ROM

**Default setting:** Auto

➤ **Intel Fast Flash Standby**

You can use this screen to select options for the Intel Fast Flash Standby Technology Configuration.

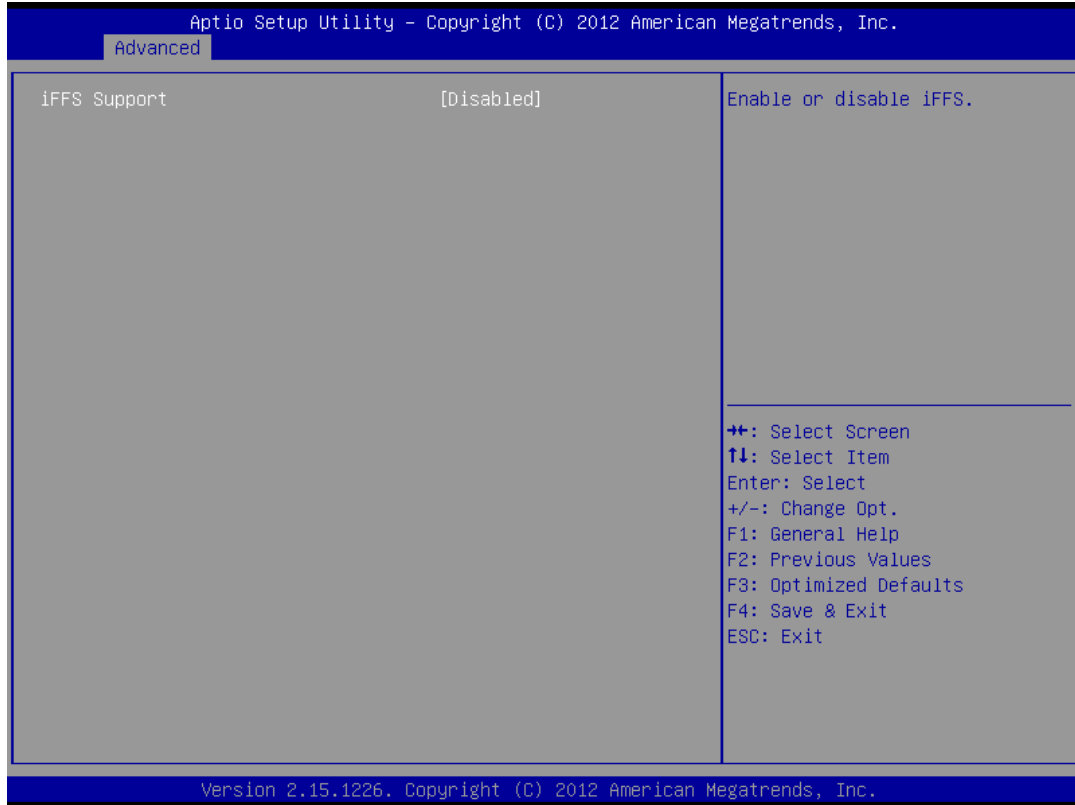

□ **iFFS Support**

This item allows users to enable or disable iFFS(Intel Fast Flash Standby). Please refer to [Chapter4 – iFFS setup procedure](#).

**Available Options:** Disabled, and Enabled

**Default setting:** Disabled

➤ **IDE Configuration**

You can use this screen to select options for the IDE devices Configuration.

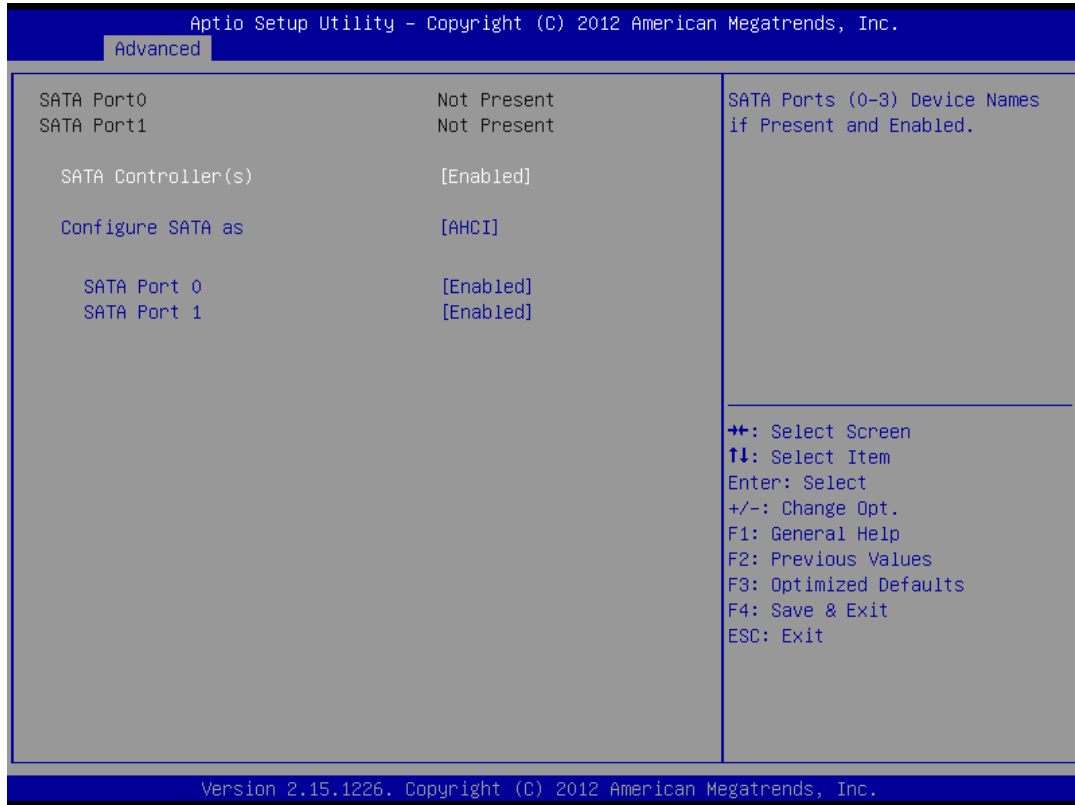

□ **SATA Controller(s)**

This item allows users to enable or disable SATA Controller.

**Available Options:** Disabled, and Enabled

**Default setting:** Enabled

□ **Configure SATA as**

Select a configuration for SATA controller. Install Windows XP in AHCI mode need to use the F6 Method pre-installed AHCI driver, if you select IDE mode, you do not need to pre-install.

**Available Options:** IDE, and AHCI

**Default setting:** AHCI

❑ **SATA Port0**

The system SATA HDD corresponding SATA port 0, this item allows users to enable or disable SATA port 0.

**Available Options:** Disabled, and Enabled

**Default setting:** Enabled

❑ **SATA Port 1**

The CFast socket corresponding to the SATA port 1, this item allows users to enable or disable SATA port 1.

**Available Options:** Disabled, and Enabled

**Default setting:** Enabled

➤ **Super IO Configuration**

This section describes the function of Super I/O settings.

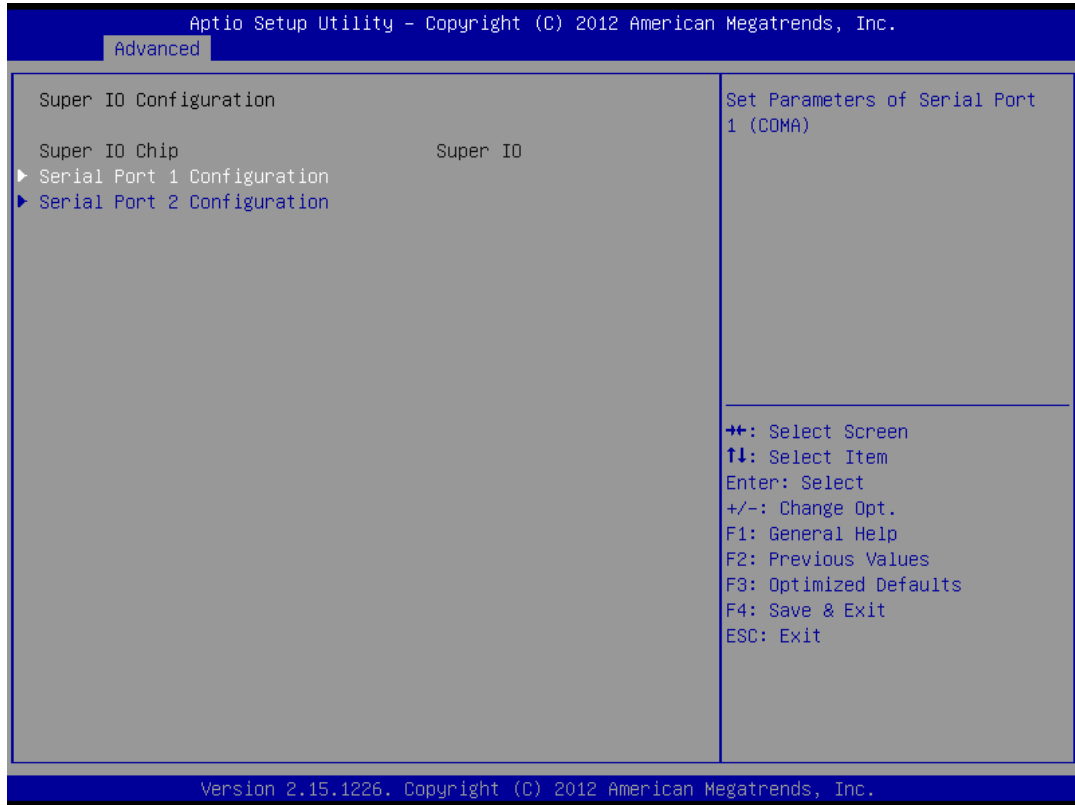

❑ **Serial Port 1 Configuration**

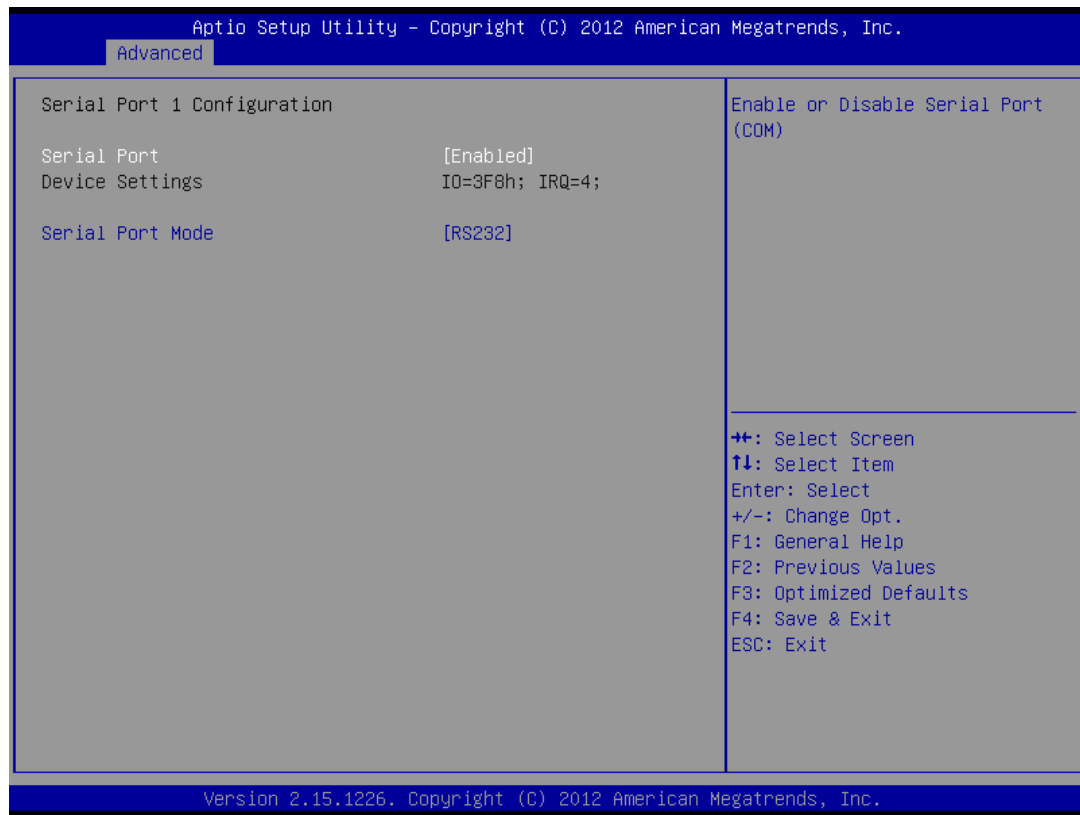

✧ **Serial Port**

This item allows users to enable or disable Serial Port 1(COM1).

**Available Options:** Disabled, and Enabled

**Default setting:** Enabled

✧ **Serial Port Mode**

These fields item can select RS-232, RS-422 and RS-485 of select port 1.

**Available Options:** RS232, RS485, and RS422

**Default setting:** RS232



❑ **Serial Port 2 Configuration**



✧ ***Serial Port***

This item allows users to enable or disable Serial Port 2 (COM2).

**Available Options:** Disabled, and Enabled

**Default setting:** Enabled

✧ ***Serial Port Mode***

These fields item can select RS-232, RS-422 and RS-485 of select port 1.

**Available Options:** RS232, RS485, and RS422

**Default setting:** RS232

➤ **H/W Monitor**

On the Hardware Monitor screen, you can monitor the system temperature, CPU voltage, and VCC3V voltage...

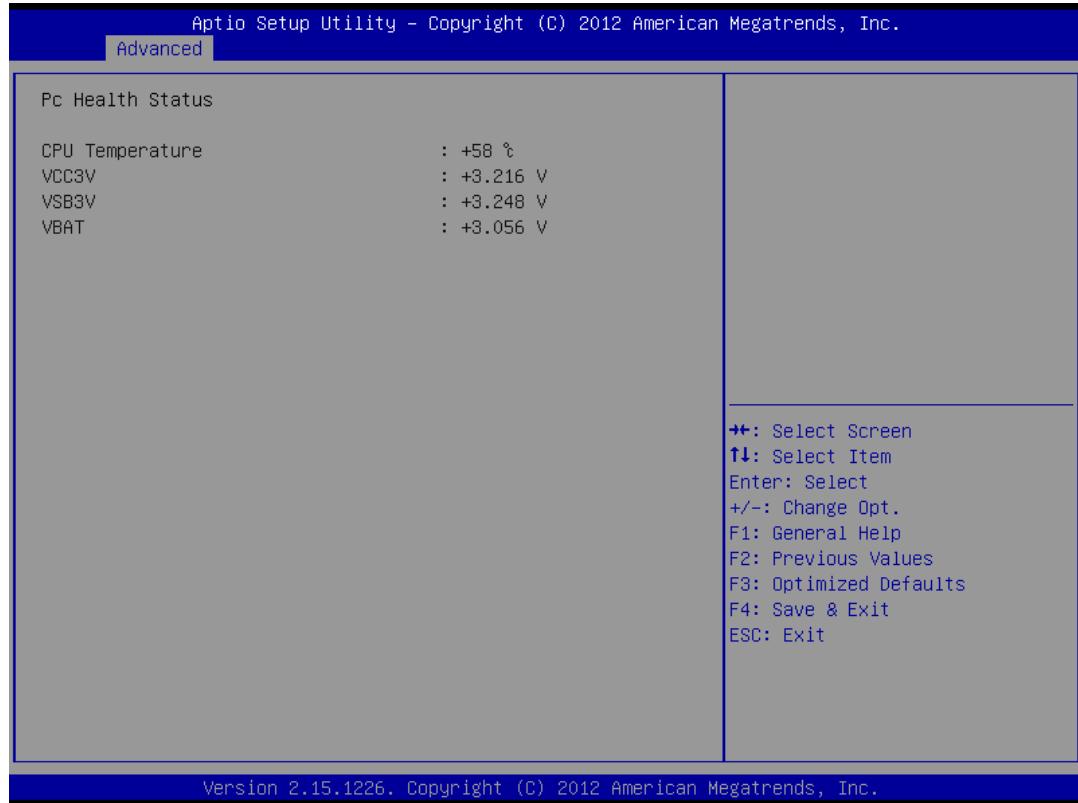

## Chipset

This section describes the configuration of the board's chipset features.

- Host Bridge
- South Bridge

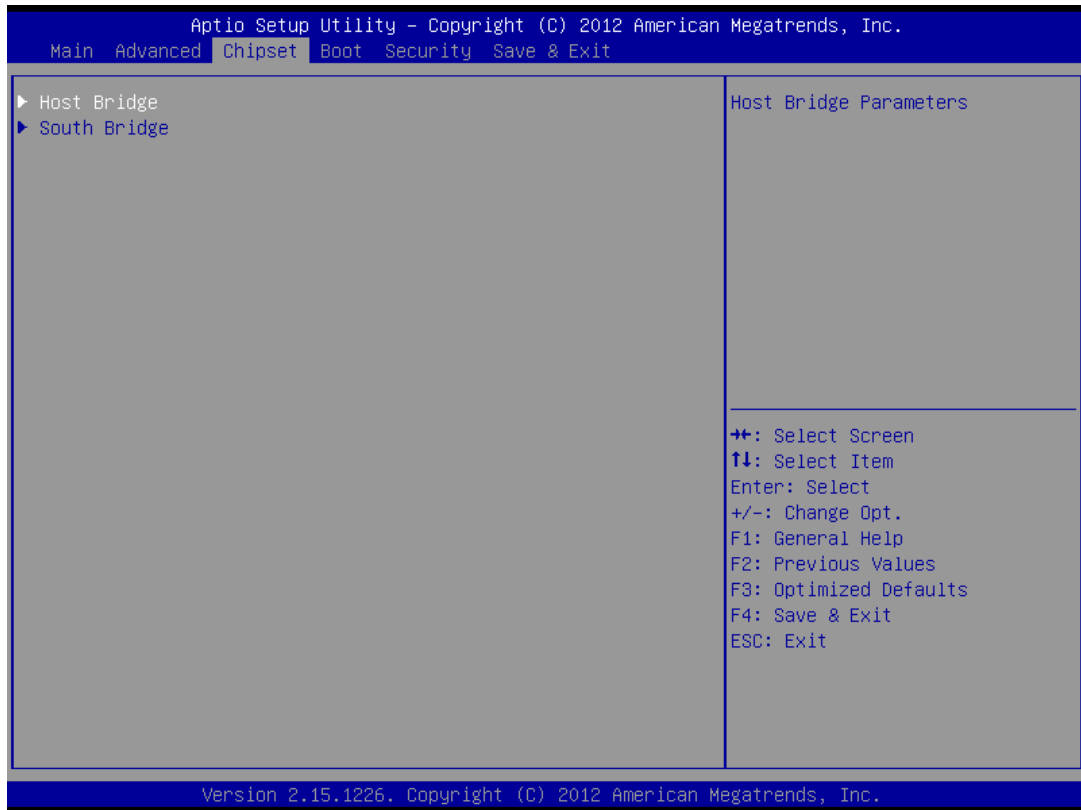

➤ **Host Bridge**

You can use this screen to select options for the Host Bridge Configuration. Use the up and down <Arrow> keys to select an item. Use the <Plus> and <Minus> keys to change the value of the selected option.

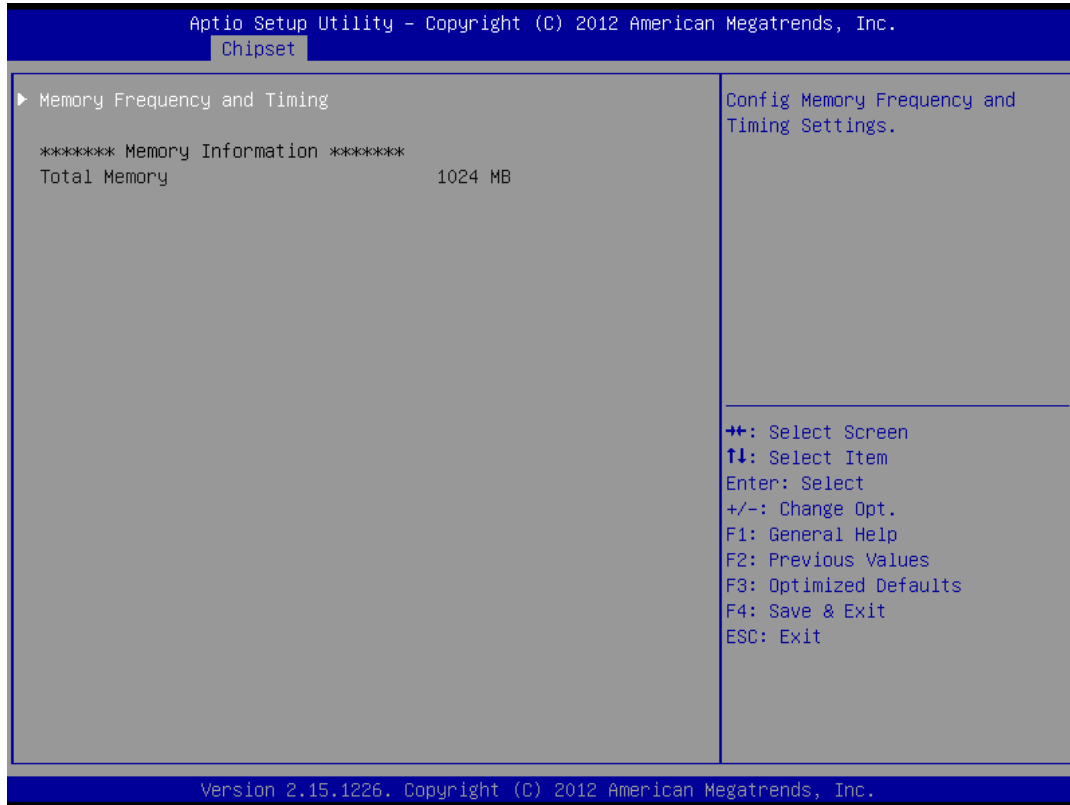

❑ **Memory Frequency and Timing**

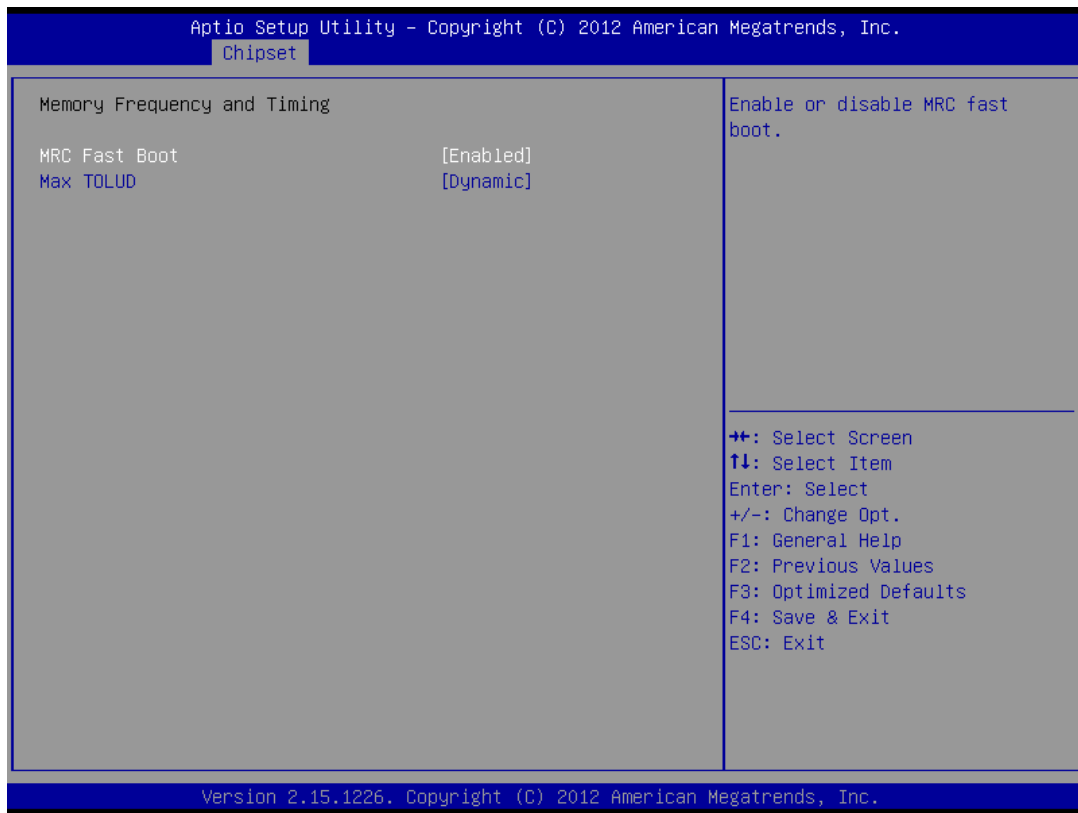

✧ ***MRC Fast Boot***

This item allows users to enable or disable MRC fast boot.

**Available Options:** Disabled, and Enabled

**Default setting:** Enabled

✧ ***Max TOLUD***

Maximum Value of TOLUD Dynamic assignment would adjust TOLUD automatically based on largest MMIO length of installed graphic controller.

**Available Options:** Dynamic, 1GB, 1.25GB, 1.5GB, 1.75GB, 2GB, 2.25GB, 2.5GB, 2.75GB, 3 GB, and 3.25GB

**Default setting:** Dynamic

➤ **South Bridge**

You can use this screen to select options for the South Bridge Configuration. South Bridge is a chipset on the motherboard that controls the basic I/O functions, LAN port, and audio function.

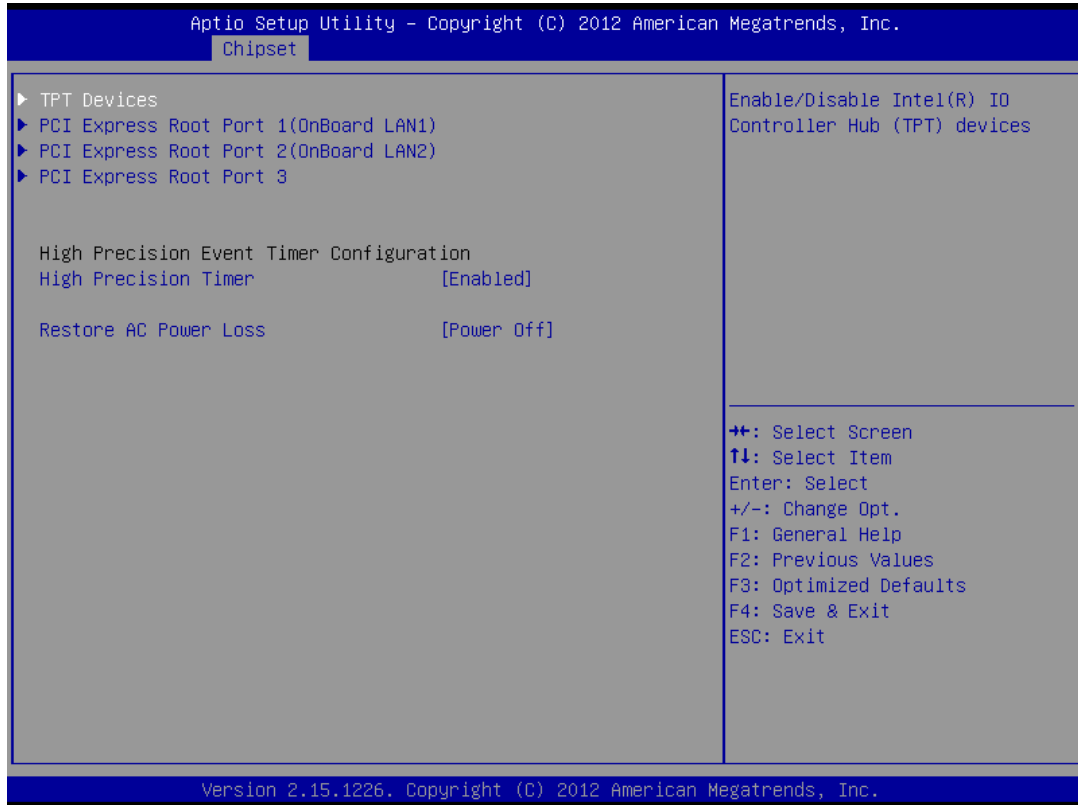

❑ **TPT Devices**

Enable/Disable Intel® IO Controller Hub (TPT) Devices.

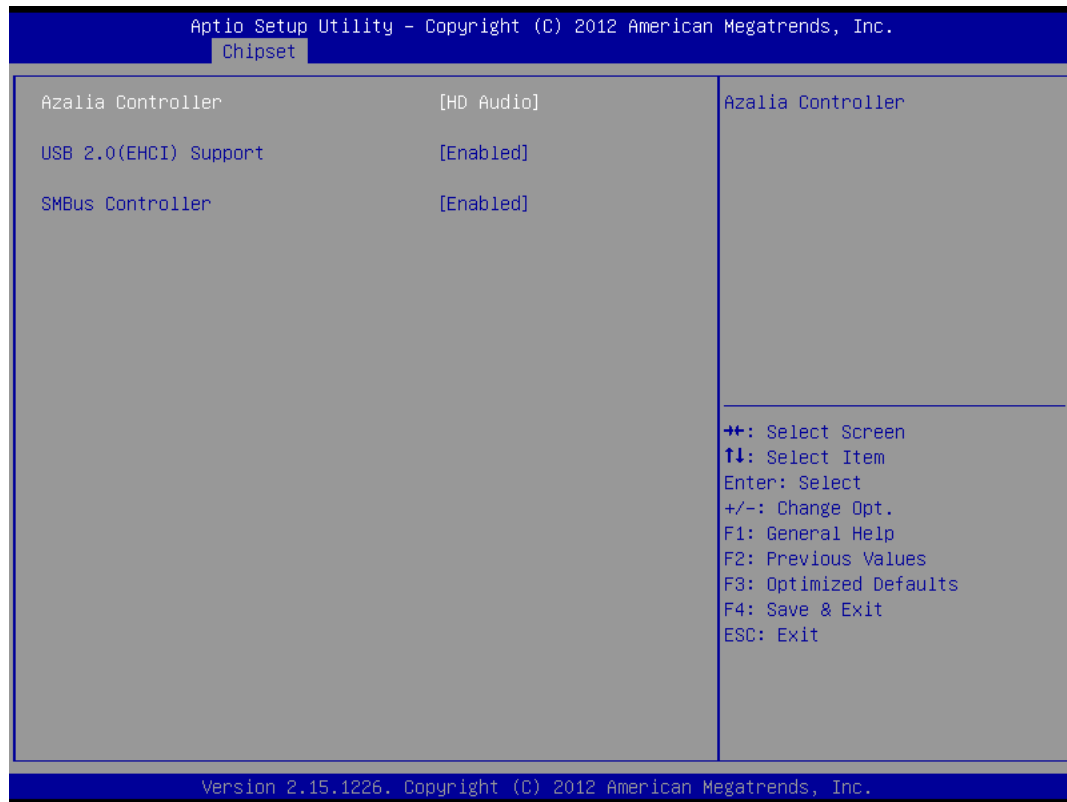

✧ ***Azalia Controller***

This item allows users to enable or disable Azalia Controller.

**Available Options:** Disabled, and HD Audio

**Default setting:** HD Audio

✧ ***USB 2.0(EHCI) Support***

This item allows users to enable or disable USB 2.0 (EHCI) Support.

**Available Options:** Disabled, and Enabled

**Default setting:** Enabled

✧ *SMBus Conotroller*

This item allows users to enable or disable on-chip SMBus controller.

**Available Options:** Disabled, and Enabled

**Default setting:** Enabled



❑ **PCI Express Root Port 1 (On Board LAN1)**

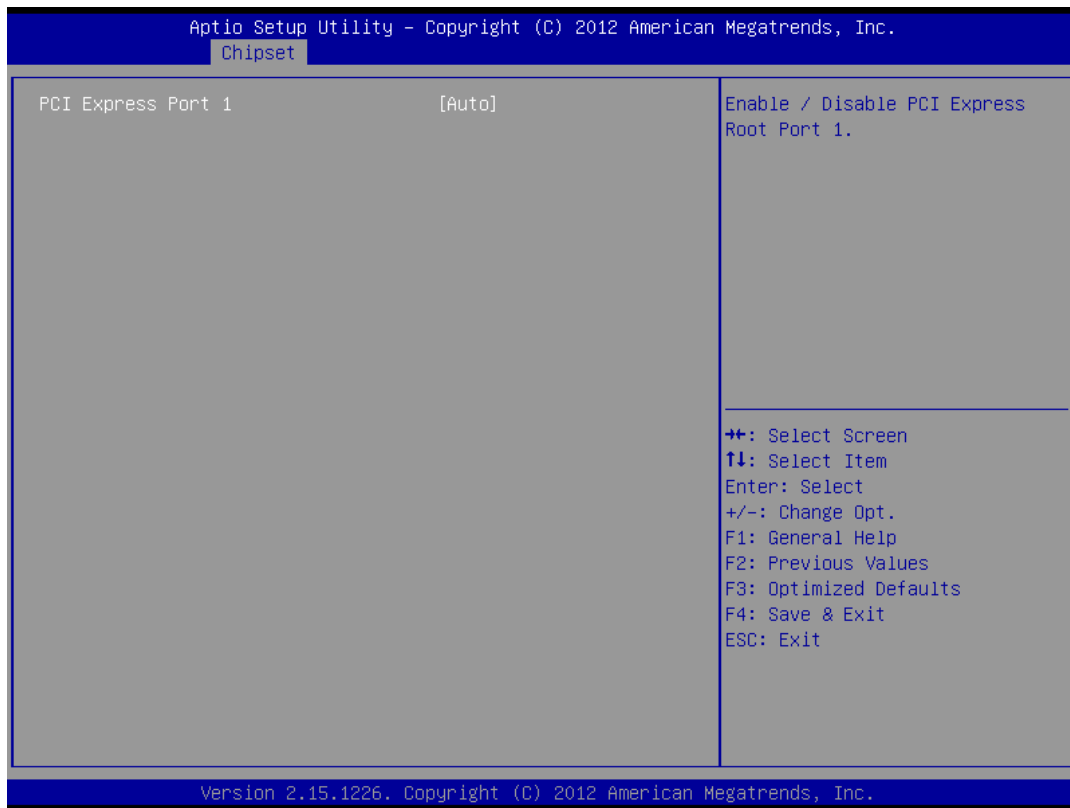

❖ ***PCI Express Port 1***

The onboard LAN1 corresponding PCI Express port 1, this item allows users to enable or disable on board LAN1.

**Available Options:** Disabled, Enabled, and Auto

**Default setting:** Auto

❑ **PCI Express Root Port 2 (On Board LAN2)**

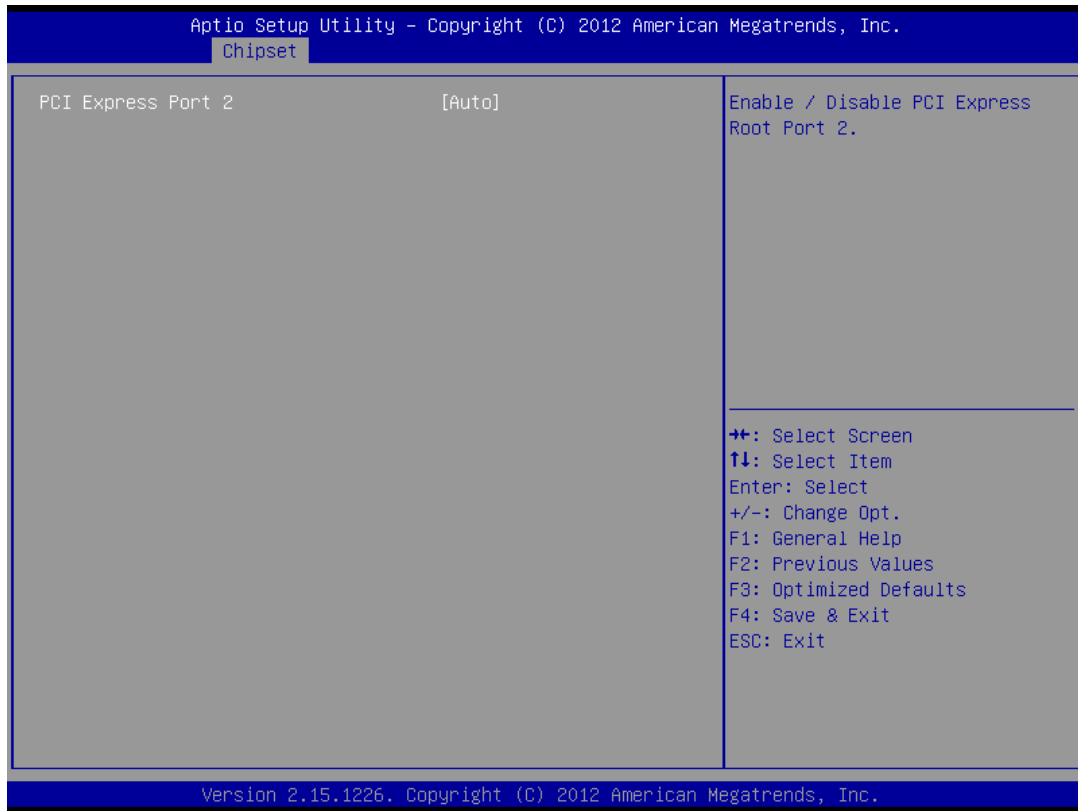

✧ *PCI Express Port 2*

The onboard LAN2 corresponding to PCI Express port 2, this item allows users to enable or disable on board LAN2.

**Available Options:** Disabled, Enabled, and Auto

**Default setting:** Auto

❑ **PCI Express Root Port 3**

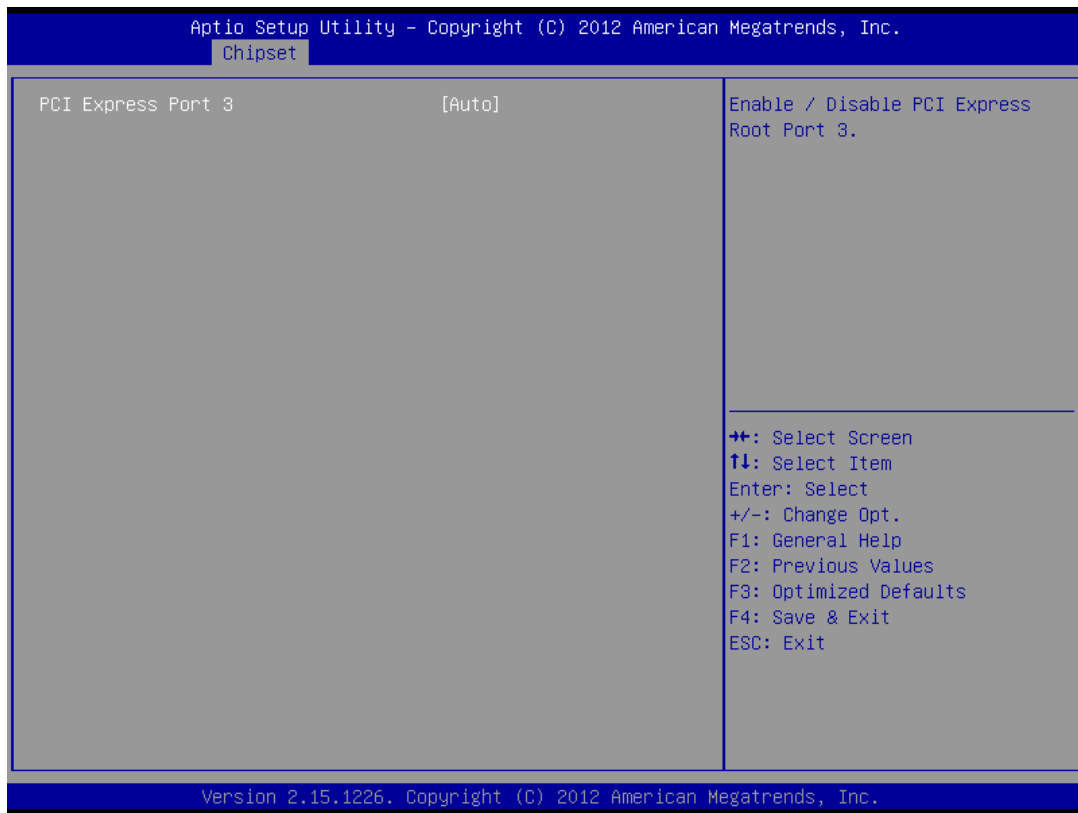

✧ *PCI Express Port 3*

The PCIe mini-Card corresponding to PCI Express port 3, this item allows users to enable or disable on board PCIe mini Card.

**Available Options:** Disabled, Enabled, and Auto

**Default setting:** Auto

❑ **High Precision Timer**

This item allows users to enable or disable the High Precision event timer.

**Available Options:** Disabled, and Enabled

**Default setting:** Enabled

❑ **Restore AC Power Loss**

This field specifies the option controls how the PC will behave once power is restored following a power outage (or other unexpected or ungraceful shutdown). The "Last State" option returns the PC to the state in effect at the time the power outage or shutdown occurred. Assign this option the "Power On" value to reboot automatically; assign the "Power Off" value to leave the machine powered down.

**Available Options:** Power Off, Power On, and Last State

**Default setting:** Power Off

## Boot

Select the *Boot* tab from the setup screen to enter the Boot BIOS Setup screen. You can select any of the items in the left frame of the screen, such as Boot Device Priority, to go to the sub menu for that item. You can display a Boot BIOS Setup option by highlighting it using the <Arrow> keys. All Boot Setup options are described in this section.

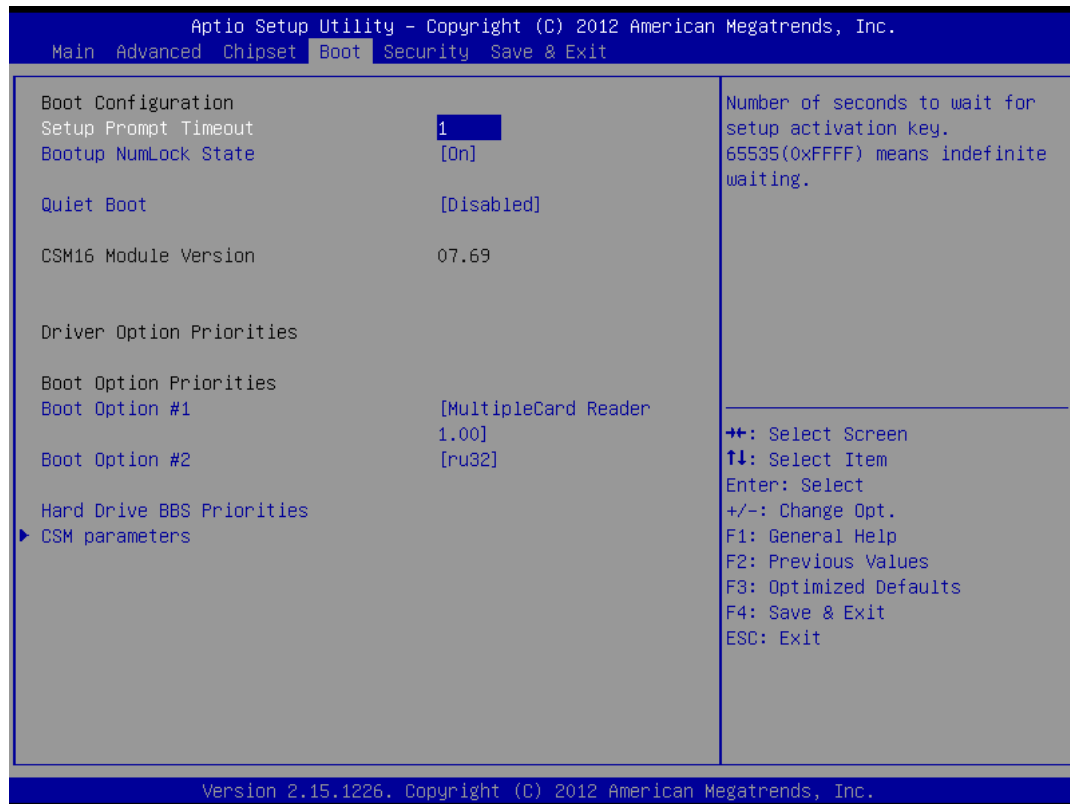

### □ Setup Prompt Timeout

This item allows users to select the number of seconds to wait for setup activation key.

**Available Options:** 1~65535

**Default setting:** 1

### □ Bootup NumLock State

This field is used to activate the Num Lock function upon system boot. If the setting is on, after a boot, the Num Lock light is lit, and user can use the number key.

**Available Options:** On, and Off

**Default setting:** On

❑ **Quiet Boot**

This item allows users to enable or disable Quiet boot option. If Enable, an OEM LOGO is shown instead of POST messages.

**Available Options:** Disabled, and Enabled

**Default setting:** Enabled

❑ **Boot Option Priorities**

This item allows users to set boot device priority. Set the boot device options to determine the sequence in which the system checks which device to boot from. The settings are Hard Driver BBS Priorities (*Removable Storage Dev., Hard Drive*), and CD/DVD ROM Driver BBS Priorities (*USB CDROM*).

**Note:** When you select a boot Option category from the boot menu, a list of devices in that category appears. For example, if the system has hard disk drives and USB storage connected, then the list will show all hard disk drives attached.

❑ **CSM parameters**

The CSM (Compatibility Support Module) is Option ROM Execution, boot options filter, ect.

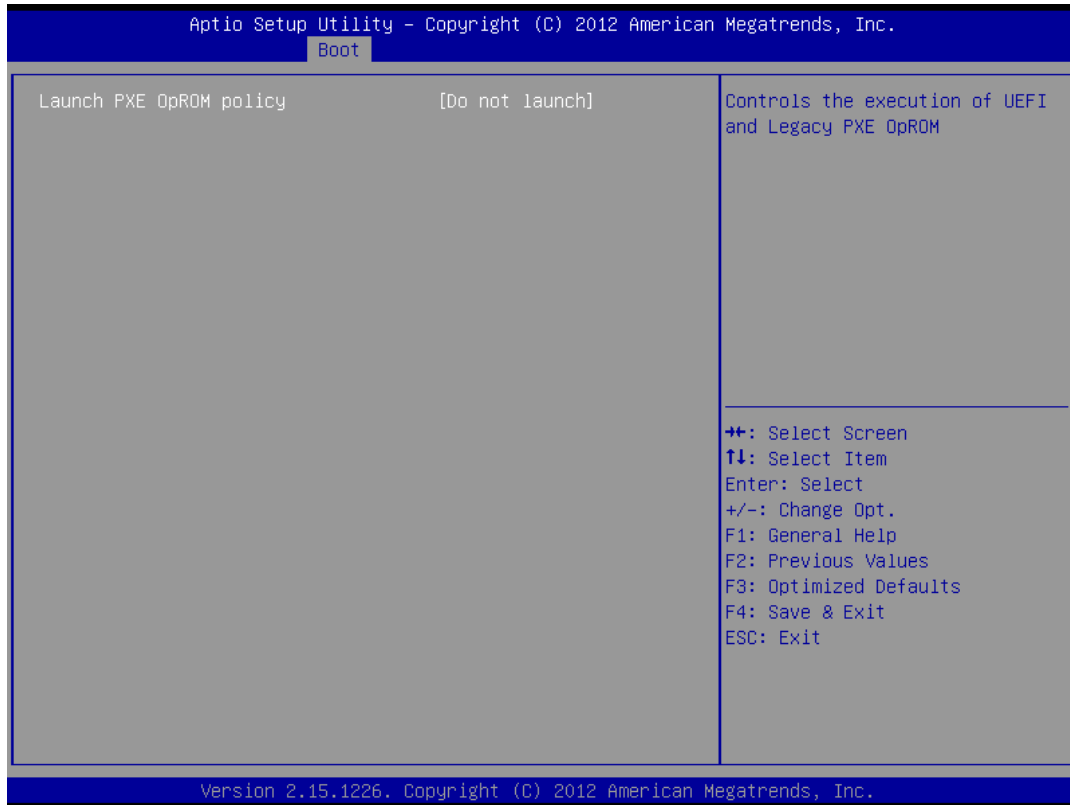

✧ ***Launch PXE OpROM policy***

This field specifies the PXE boot ROM of the onboard LAN1 or LAN2 chip.

**Available Options:** Do not launch, and Legacy only

**Default setting:** Do not launch

## Security

Security Setup provides both Administrator and User password. If you use both passwords, the Administrator password must be set first. The system can be configured so that all users must enter a password every time the system boots or when Setup is executed, using either the Administrator password or User password. The Administrator and User passwords activate two different levels of password security. If you select password support, you are prompted for a three to twenty character password. Type the password on the keyboard. The password does not appear on the screen when typed. Make sure you write it down. If you forget it, you must drain NVRAM and reconfigure.

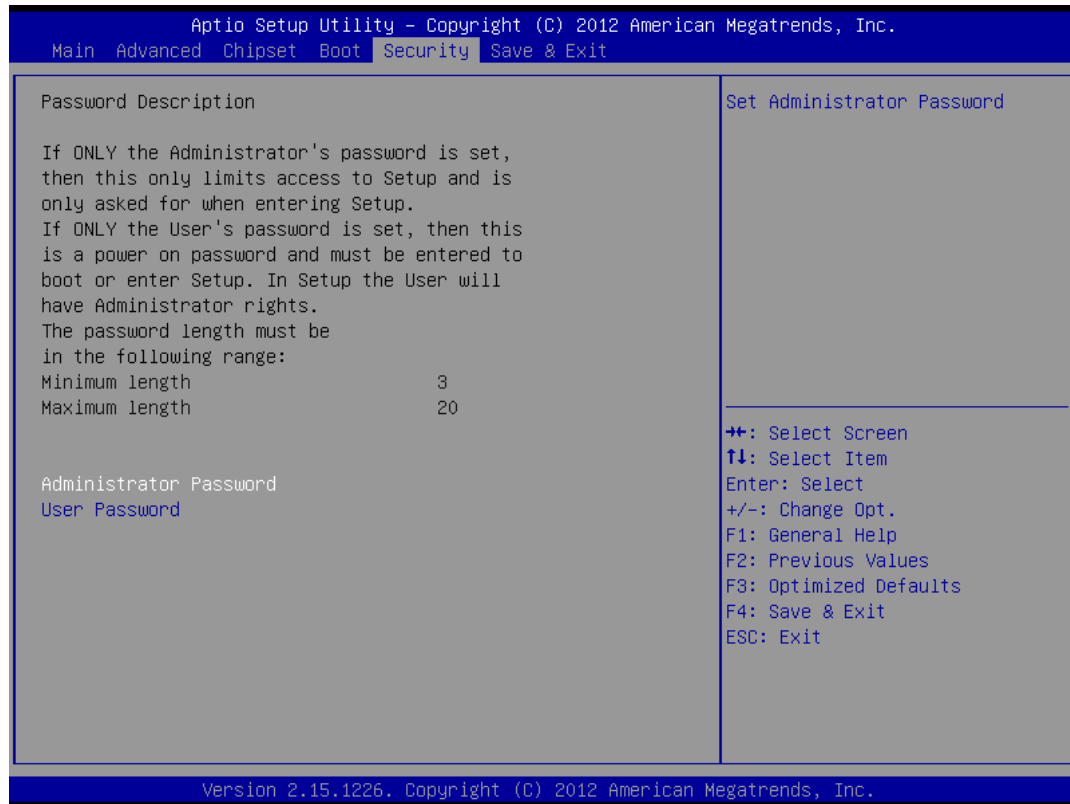

### □ Install Administrator/User Password

Select Administrator/User Password item, press <Enter> and type new password (up to 3 character length) and confirm new password. The screen does not display the characters entered.

### ❖ *Change Administrator/User Password*

Select Administrator/user password item, press <Enter> and type current password, at the next dialog type new password and confirm new password.



❖ *Clear Old Password*

Select Administrator/user password item, press <Enter> and type current password, at the next dialog press <Enter> to Clear Old Password.

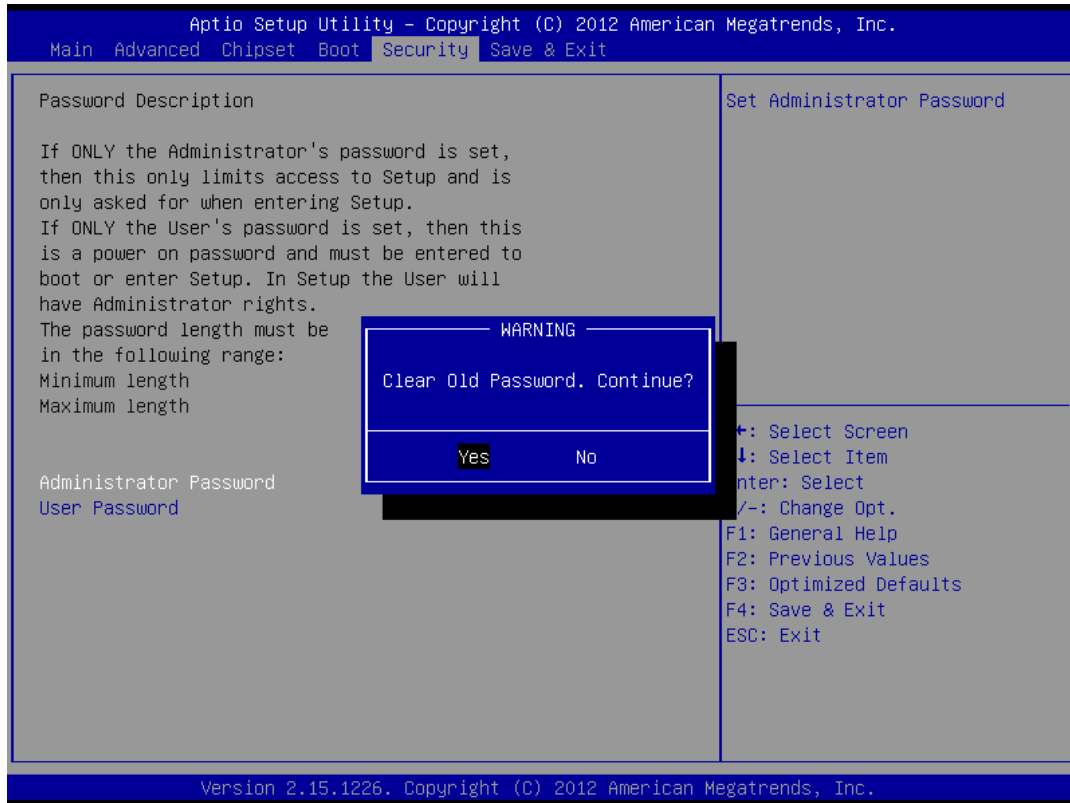

## Save & Exit

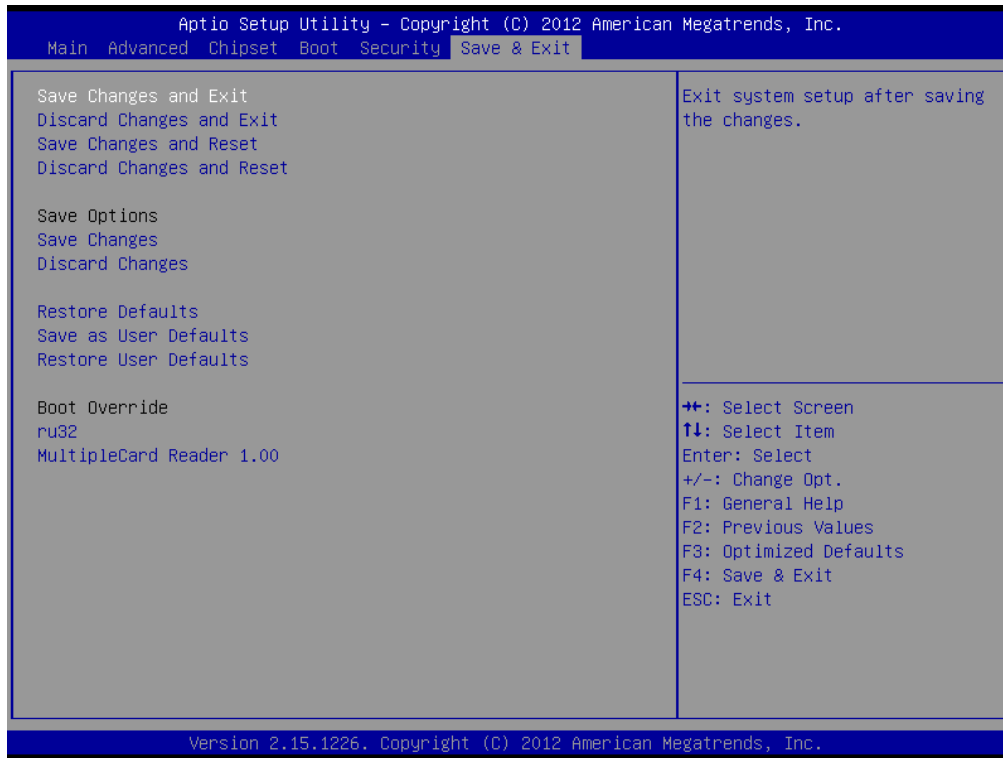

### ❑ Save Changes and Exit

When you have completed the system configuration changes, select this option to save the changes and Exit, so the new system configuration parameters can take effect.

### ❑ Discard Changes and Exit

Select this option to quit without making any modifications to the system configuration.

### ❑ Save Changes and Reset

When you have completed the system configuration changes, select this option to save the changes and reboot the system, so the new system configuration parameters can take effect. The following window will appear after selecting the 'Save Changes and Reset' option selected. Reset the system after saving the changes.

**Discard Changes and Reset**

Select this option to reboot the system without saving the changes done in the setup configuration.

**Save Changes**

When you have completed the system configuration changes, select this option to save your system configuration and continue. For some of the options it required to reset the system to take effect...

**Discard Changes**

When you have completed the system configuration changes, select this option to undo the previous changes.

**Restore Defaults**

Restore/Load Default values for all the setup options.

**Save as User Defaults**

Save the changes done so far as User Defaults.

**Restore User Defaults**

Restore the User Defaults to all the setup option.

## Chapter 4 Software Installation

The enclosed CD diskette includes FX5326 VGA, System, CAN, I/O and LAN driver. To install and configure you FX5326 system, you need to perform the following steps.

### System Driver

#### WIN XP/7 Driver

Installs Atom N2600 Chipset, Core PCI, PCIe, SATA, USB, ISAPnP and IDE/ATA Device Drive.

Step 1: To install the Atom N2600 driver, insert the CD ROM into the CD ROM device, and enter DRIVER>SysChip>NM10.

Step 2: Execute INF\_allOS\_9.2.2.1034\_PV.exe file.

Step 3: The screen shows the SETUP type. Press any key to enter the main menu.

Step 4: As the setup is completed, the system will generate the message as follows.

Yes, I want to restart my computer now. Installation is done.

No, I will restart my computer later.

System must be restart then complete the installation.

## VGA Driver

### WIN XP/7 Driver

Step 1: To install the VGA driver, insert the CD ROM into the CD ROM device, and enter DRIVER>VGA> ATOM\_CedarTrail>WIN7 or >WINXP\_CRT\_Only.

Step 2: Execute SETUP.EXE file.

Step 3: The screen shows the SETUP type. Press any key to enter the main menu.

Step 4: As the setup is completed, the system will generate the message as follows.

Yes, I want to restart my computer now. Installation is done.

No, I will restart my computer later.

System must be restart then complete the installation.

**Note:** In the DRIVER>VGA>ATOM\_CedarTrail >WIN7 directory, a Readme.txt file is included to provide installation information.

## Audio Driver

### WIN XP/7 Driver

Step 1: To install the AUDIO driver, insert the CD ROM into the CD ROM device, and enter DRIVER>AUDIO>ALC888>WIN7 or >WIN2K&XP.

Step 2: Execute 32bit\_Win7\_R270.exe file.

Step 3: The screen shows the SETUP type. Press any key to enter the main menu.

Step 4: As the setup is completed, the system will generate the message as follows.

Yes, I want to restart my computer now. Installation is done!

No, I will restart my computer later.

System must be restart then complete the installation.

## **LAN Driver (RTL 8111F)**

### **WIN XP/7 Driver**

- Step 1: To install the LAN driver, insert the CD ROM into the CD ROM device, and enter DRIVER>LAN>RTL8111F\WIN7 or >XP. If your system is not equipped with a CD ROM device, copy the LAN driver from the CD ROM to CF.
- Step 2: Execute setup.exe file.

## **BIOS Flash Utility**

In the <UTILITY> directory, there is the Afu301.EXE file.

- Step 1: Use the Afu301.EXE program to update the BIOS setting.
- Step 2: And then refer to the chapter "BIOS Setup", as the steps to modify BIOS.
- Step 3: Now the CPU board's BIOS loaded with are the newest program; user can use it to modify BIOS function in the future, when the BIOS add some functions.

## iFFS Setup Procedure

STEP1: Install WIN7 on SSD.

- While installing, partition a portion of SSD which will be used for iFFS.
- Size of this partition has to be a minimum of the DRAM size.
- It is recommended, if possible, to make this partition at least as big as the largest DRAM that can be used on this platform.

STEP2: Once OS is installed, perform the following partition steps. This is necessary for BIOS to identify the partition on SSD that it needs to use for iFFS.

- Master Boot Record format:
  - Go to Control Panel-> System and Security-> Administrative Tools-> Computer Management-> Disk Management.
  - Select the allocated partition on SSD for iFFS.
  - Right click, select "Shrink Volume".

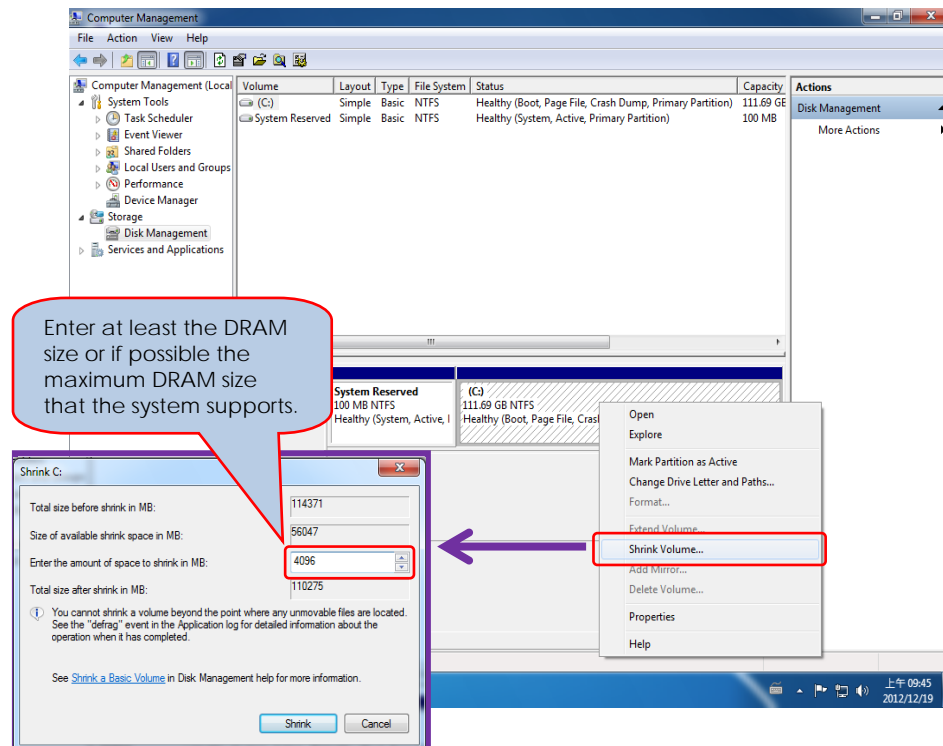

SETP3: Reserving partition as hibernation partition:

- Launch Disk Partitioning tool – standard tool available in Windows 7.
- Go to . Type cmd.exe in the search bar.
- Type diskpart.exe and press enter.
- Click on yes when it prompts for User Account Control DiskPart. A new window for diskpart will show up as shown below.

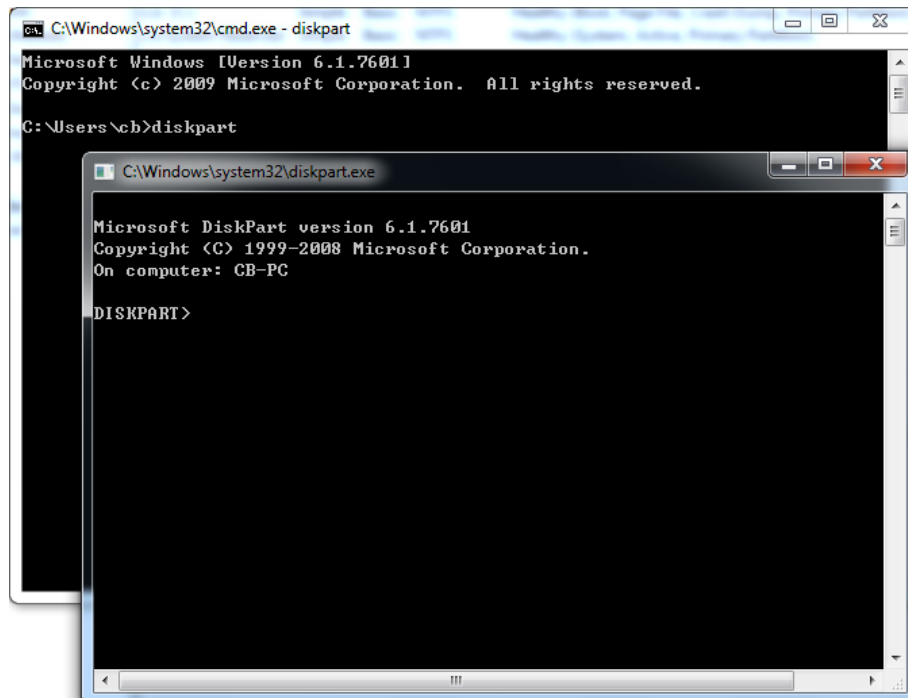

- Type the following commands in the command prompt:
  - DISKPART> list disk
  - DISKPART> select disk X  
(X is disk number where you want to create the store partition. Refer to results from “list disk” for exact disk number.)
  - DISKPART> create partition primary
  - DISKPART> detail disk
  - DISKPART> select Volume X  
(X is Volume of your store partition. Refer to results from “detail disk” for exact volume number.)
  - DISKPART> set id=84 override  
(The id must be set to 84.)



- The hibernation partition will be identified as shown below.

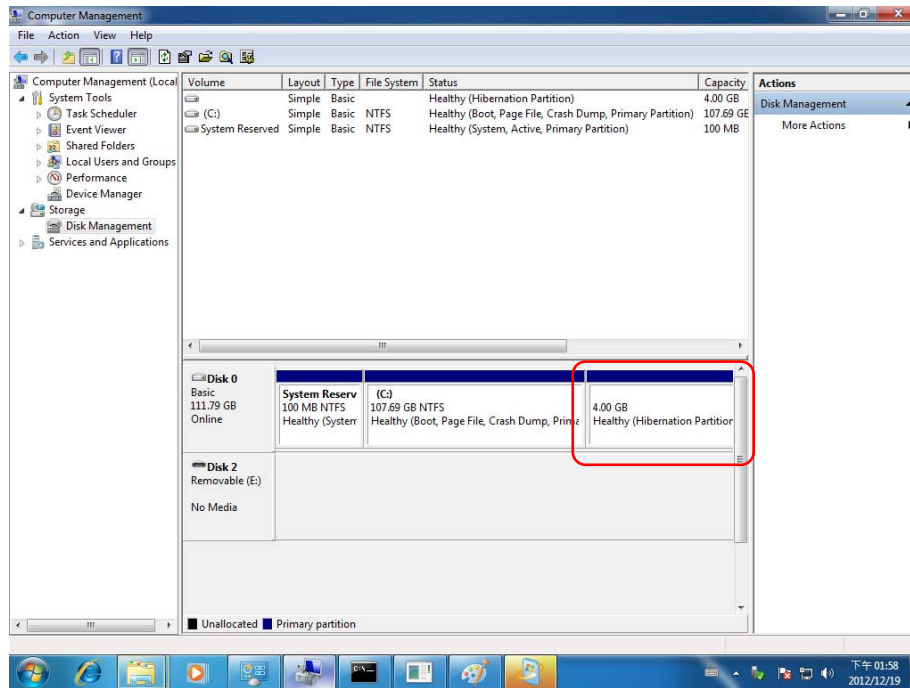

SETP4: Boot up the system and go into BIOS setup. Go to Advanced tab and select Intel Fast Flash Standby.

- iFFS Support Enabled
- Save and Exit

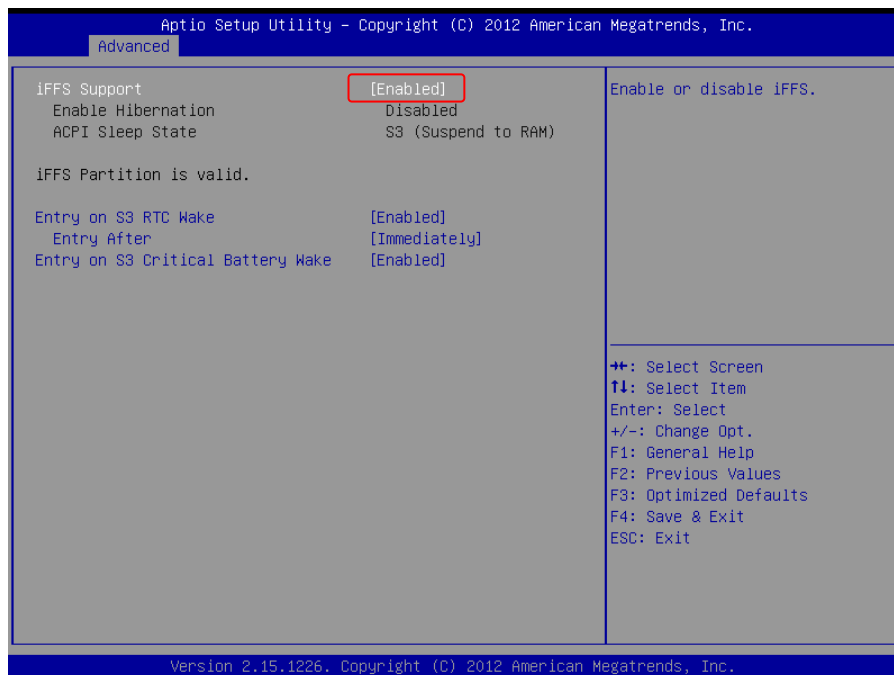

## Watchdog Timer

This section describes how to use the Watchdog Timer, including disabled, enabled, and trigger functions.

The FX5326 is equipped with a programmable time-out period watchdog timer. You can use your own program to Enabled the watchdog timer. Once you have enabled the watchdog timer, the program should trigger the I/O every time before the timer times out. If your program fails to trigger or disable this timer before it times out, e.g. because of a system hang-up, it will generate a reset signal to reset the system. The time-out period can be programmed to be set from 1 to 255 seconds or minutes.

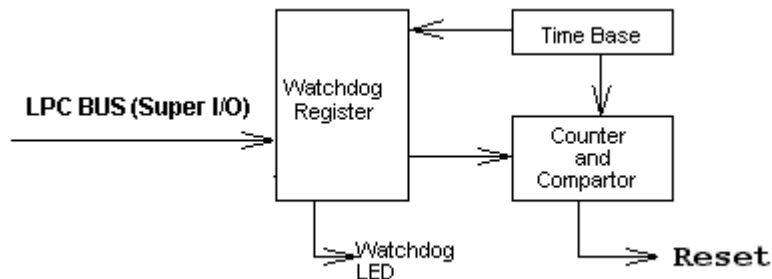

The CD includes a Watch Dog demo file. In the WATCHDOG/F81216D/TURBOC: Library and Test Program written in Turbo C++

The WATCHDOG includes a demonstration program established for users who would like to configure the Watchdog timer by themselves.

**Note:** In the WATCHDOG/F81216D directory, README.TXT file is included to provide demo program information.

If use the watchdog Turbo C++ demo program, need the modify watchdog register whose address index is 0x2e and data port is 0x2f, and watchdog trigger and timer I/O is set to 0x308 and 0x309. Like below:

```

#define equIndexPort 0x2e /*super IO of index port for Super I/O/
#define equDataPort 0x2f /*super IO of data port for Super I/O */
#define WDTCS 0x308 /*set Watch Dog timer configuration status */
#define WDTtimer 0x309 /*set WDT Timer and Enable */
  
```

### Watchdog Timer Setting

The watchdog timer is a circuit that may be used from your program software to detect system crashes or hang-ups. The watchdog timer is automatically disabled after reset.

Once you have enabled the watchdog timer, your program must trigger the watchdog timer every time before it times out. After you trigger the watchdog timer, it will be set to non-zero value to watchdog counter and start to count down again. If your program fails to trigger the watchdog timer before time-out, it will generate a reset pulse to reset the system.

The factor of the watchdog timer time-out constant is approximately 1 second. The period for the watchdog timer time-out is between 1 to FF timer factors.

If you want to reset your system when watchdog times out, the following table listed the relation of timer factors between time-out periods.

Time Factor	Time-Out Period (Seconds)	Time-Out Period (Minutes)
1	1	1
2	2	2
3	3	3
4	4	4
5	5	5
"	"	"
"	"	"
"	"	"
FF	FF	FF

### Watchdog Timer Enabled

To enable the watchdog timer, you have to output a byte of timer factor to the watchdog register whose address is 2eh and data port is 2fH. The following is an Assemble program, which demonstrates how to enable the watchdog timer and set the time-out period at 28 seconds.

```
-----  
; Enter the extended function mode, interruptible double-write  
-----  
Mov     dx, 2eh           ; Enter to extended function mode  
Mov     al, 87h  
Out     dx, al  
Out     dx, al  
Mov     al, 07h          ; Select register index 0x07  
Out     dx, al  
-----  
; Logical device 8, configuration WD IO Port 308H register, CR60 Bit 1,2,CR61 Bit 0-7  
-----  
Mov     dx, 2fh           ; Select LDN 8  
Mov     al, 08h  
Out     dx, al  
Mov     dx, 2eh  
Mov     al, 60h          ; Select LDN 8 register index 0x60  
Out     dx, al  
Mov     dx, 2fh  
Mov     al, 03h          ; Set Watch Dog timer base address high byte to 0x03h  
Out     dx, al  
Mov     dx, 2eh  
Mov     al, 61h          ; Select LDN 8 register index 0x61  
Out     dx, al  
Mov     dx, 2fh  
Mov     al, 20h          ; Set Watch Dog Timer base address low byte to 0x08h  
Out     dx, al  
-----  
; Logical device 8, configuration register, CR30 Bit 0, Enable Watch Dog Timer Device  
-----  
Mov     dx, 2eh  
Mov     al, 30h          ; Select LDN 8 register index 0x30  
Out     dx, al  
Mov     dx, 2fh  
Mov     al, 01h          ; Enable Watch Dog Timer Device  
; Mov     al, 00h          ; Disable Watch Dog Timer Device  
Out     dx, al  
-----  
; Exit extended function mode  
-----  
Mov     dx, 2eh  
Mov     al, 0aah  
Out     dx, al
```

### Watchdog Timer Trigger

After you enable the watchdog timer, your program must write the same factor as enabling to the watchdog register at least once every time-out period to its previous setting. You can change the time-out period by writing another timer factor to the watchdog register at any time, and you must trigger the watchdog before the new time-out period in next trigger.

```

;-----
; Set Watch Dog timer to 20 second used base address 308H~309H:
; 308H- Bit 0 read state: When '0' is no time out occur, '1' is timer out occurred
; And write "1" is clear out status.
; 309H is timer unit: Bit1 is set to unit second and Bit2 is set to unit minute.
;-----

```

```

Mov     ax,03h      ;Select unit to Second (Bit-1) and clear time out status (Bit-0)
;Mov    ax,05h      ;Select unit to Minute (Bit-2) and clear time out status (Bit-0)
Mov     dx,308h
Out     dx,ax
Mov     ax,14h      ;Set timer to 20 second and enable time
Mov     dx,309h
Out     dx,ax       ; Write the same non-zero value twice to enable the timer,
Out     dx,ax       ; otherwise will disable timer.

```

### Watchdog Timer Disabled

To disable the watchdog timer, simply write a 00H to the watchdog register.

```

;-----
; Enter the extended function mode, interruptible double-write
;-----
Mov     dx, 309h    ; Enter to extended function mode
Mov     al, 00h
Out     dx,al
Out     dx,al

```

## Digital I/O programming

The following is an Assembly program, which demonstrates how to read and write the data of GPIO.

```
-----  
; Configuration the Digital IO port is 50Ch, and Bit2, Bit3, Bit4, Bit5  
; Bit3/Bit2 (GPO-0 ~ GPO-1 Write data port)  
;     When set to a "1", respective GPO port is programmed as 'High'.  
;     When set to a "0", respective GPO port is programmed as 'Low'.  
; Bit5/Bit4 (GPI-0 ~ GPI-1 Read data port.)  
;     Its respective bit only read.  
-----  
Mov     dx,50ch      ; Digital I/O port 50Ch  
Mov     al,0ch       ; set GPO-0(Bit3) ~ GPO-1(Bit2) value is "xxxx11xxb"  
Out     dx,al        ; Set GPO-0 ~ GPO-1 value  
  
Mov     dx,50ch  
In      al,dx        ; read GPI-0 (Bit5) ~ GPI-1 (Bit4) value "xx11xxxxb"
```

## CANBUS

This section describes how to program and use the CAN BUS. It provides a Description of the I/O memory map of the chip and discussion of the internal registers to aid you in programming your CAN controller chip.

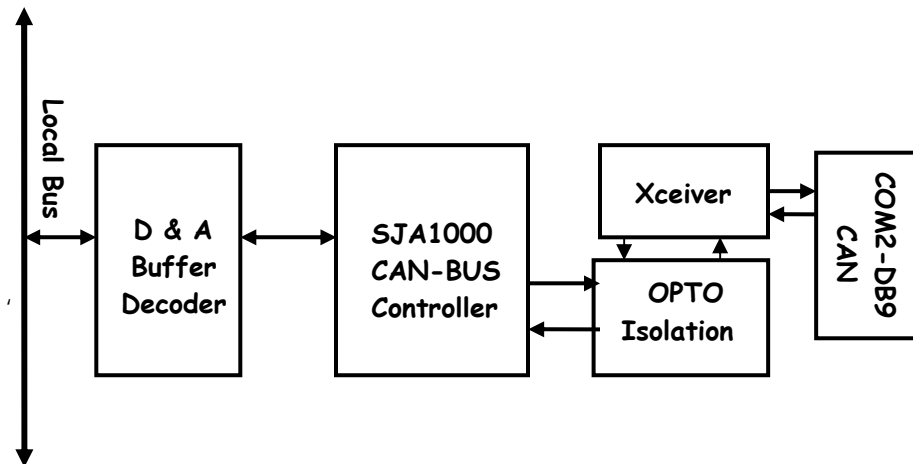

### Defined Memory Mapping And Interrupt

The CANBUS occupies 2 bytes of FX5326 memory space. You can set the base address and access to the internal resources of the SJA1000 CAN controller chip. The SJA1000 chip access is multiplexed in such a way that the host must first write to 300h the internal address of the CAN chip and after that perform a write to address 301h with the actual data to be written into the desired memory location. Address 302h is a hardware-reset function of the SJA1000. Performing a read or write to this address will cause a hardware reset to the CAN controller. You may need to reset the chip in case of an unrecoverable error in the CAN controller chip. And you can use interrupt the main processor when a message is received or transmitted if interrupts are enabled on the FX5312. By using interrupts you can write powerful code to CAN.

Description	Factory Setting
Base Address	300H
Data Of Address	301H
Hardware Reset Of SJA1000 Chips	302H
Interrupt Require Quest	11

### Example Programming

Write 300H to the CAN controller Control byte located in the on-chip address 0. The Example is listed below:

Outportb (0x300,0x00) ; Write CAN Address 0 (Control Register )

Outportb (0x301,0x78) ; Write Data of CAN Address 0 (Control Register )

**Note:** In the DRIVER/CANBUS/SJA1000 directory a demo file is included to provide CAN control information and Turbo-C DEMO program. And Please see "SJA1000.pdf" on your CD-ROM for further information on the SJA1000 chip.





## Chapter 5 Technical Reference

This section outlines the errors that may occur when you operate the system, and also gives you the suggestions on solving the problems.

Topic include:

- Trouble Shooting for Post Beep & Error Messages
- Technical Reference

### Trouble Shooting for Post Beep and Error Messages

The following information informs the Post Beep & error messages. Please adjust your systems according to the messages below. Make sure all the components and connectors are in proper position and firmly attached. If the errors still exist, please contact with your distributor for maintenance.

#### ❑ POST BEEP

Currently there are two kinds of beep codes in BIOS setup.

- One indicates that a video error has occurred and the BIOS cannot initialize the video screen to display any additional information. This beep code consists of a single long beep followed by three short beeps.
- The other indicates that an error has occurred in your DRAM. This beep code consists of a constant single long beep.

#### ❑ CMOS BATTERY FAILURE

When the CMOS battery is out of work or has run out, the user has to replace it with a new battery.

❑ **CMOS CHECKSUM ERROR**

This error informs that the CMOS has corrupted. When the battery runs weak, this situation might happen. Please check the battery and change a new one when necessary.

❑ **DISK BOOT FAILURE**

When you can't find the boot device, insert a system disk into Drive A and press < Enter >. Make sure both the controller and cables are all in proper positions, and also make sure the disk is formatted. Then reboot the system.

❑ **DISKETTE DRIVES OR TYPES MISMATCH ERROR**

When the diskette drive type is different from CMOS, please run setup or configure the drive again.

❑ **ERROR ENCOUNTERED INITIALIZING HARD DRIVE**

When you can't initialize the hard drive, ensure the following things:

1. The adapter is installed correctly
2. All cables are correctly and firmly attached
3. The correct hard drive type is selected in BIOS Setup

❑ **ERROR INITIALIZING HARD DISK CONTROLLER**

When this error occurs, ensure the following things:

1. The cord is exactly installed in the bus.
2. The correct hard drive type is selected in BIOS Setup
3. Whether all of the jumpers are set correctly in the hard drive

❑ **FLOPPY DISK CONTROLLER ERROR OR NO CONTROLLER PRESENT**

When you cannot find or initialize the floppy drive controller, please ensure the controller is in proper BIOS Setup. If there is no floppy drive installed, ensure the Diskette Drive selection in Setup is set to NONE.

❑ **KEYBOARD ERROR OR NO KEYBOARD PRESENT**

When this situation happens, please check keyboard attachment and no keys being pressed during the boot. If you are purposely configuring the system without a keyboard, set the error halt condition in BIOS Setup to HALT ON ALL, BUT KEYBOARD. This will cause the BIOS to ignore the missing keyboard and continue the boot procedure.

❑ **MEMORY ADDRESS ERROR**

When the memory address indicates error, you can use this location along with the memory map for your system to find and replace the bad memory chips.

❑ **MEMORY SIZE HAS CHANGED**

Memory has been added or removed since last boot. In EISA mode, use Configuration Utility to re-configure the memory configuration. In ISA mode enter BIOS Setup and enter the new memory size in the memory fields.

❑ **MEMORY VERIFYING ERROR**

It indicates an error verifying a value is already written to memory. Use the location along with your system's memory map to locate the bad chip.

❑ **OFFENDING ADDRESS MISSING**

This message is used in connection with the I/O CHANNEL CHECK and RAM PARITY ERROR messages when the segment that has caused the problem cannot be isolated.

❑ **REBOOT ERROR**

When this error occurs that requires you to reboot. Press any key and the system will reboot.

❑ **SYSTEM HALTED**

Indicates the present boot attempt has been aborted and the system must be rebooted. Press and hold down the CTRL and ALT keys and press DEL.

## Technical Reference

### Physical and Environmental

Temperature: Operating 0°C ~ 50°C

Relative humidity 5 % to 95 % non-condensing

Surface Temperature of Chassis :

5°C to 45°C (W/HDD)/0°C to 50°C (W/CF card only)

## Serial Ports

The ACEs (Asynchronous Communication Elements ACE1 to ACE2) are used to convert parallel data to a serial format on the transmit side and convert serial data to parallel on the receiver side. The serial format, in order of transmission and reception, is a start bit, followed by five to eight data bits, a parity bit (if programmed) and one, one and half (five-bit format only) or two stop bits. The ACEs are capable of handling divisors of 1 to 65535, and produce a 16x clock for driving the internal transmitter logic.

Provisions are also included to use this 16x clock to drive the receiver logic, also included in the ACE a completed MODEM control capability, and a processor interrupt system that may be software tailored to the computing time required to handle the communications link.

The following table is a summary of each ACE accessible register

DLAB	Port Address	Register
0	Base + 0	Receiver buffer (read)
		Transmitter holding register (write)
0	Base + 1	Interrupt enable
X	Base + 2	Interrupt identification (read only)
X	Base + 3	Line control
X	Base + 4	MODEM control
X	Base + 5	Line status
X	Base + 6	MODEM status
X	Base + 7	Scratched register
1	Base + 0	Divisor latch (least significant byte)
1	Base + 1	Divisor latch (most significant byte)

❑ **Receiver Buffer Register (RBR)**

Bit 0-7: Received data byte (Read Only)

❑ **Transmitter Holding Register (THR)**

Bit 0-7: Transmitter holding data byte (Write Only)

❑ **Interrupt Enable Register (IER)**

Bit 0: Enable Received Data Available Interrupt (ERBFI)

Bit 1: Enable Transmitter Holding Empty Interrupt (ETBEI)

Bit 2: Enable Receiver Line Status Interrupt (ELSI)

Bit 3: Enable MODEM Status Interrupt (EDSSI)

Bit 4: Must be 0

Bit 5: Must be 0

Bit 6: Must be 0

Bit 7: Must be 0

□ **Interrupt Identification Register (IIR)**

Bit 0: "0" if Interrupt Pending

Bit 1: Interrupt ID Bit 0

Bit 2: Interrupt ID Bit 1

Bit 3: Must be 0

Bit 4: Must be 0

Bit 5: Must be 0

Bit 6: Must be 0

Bit 7: Must be 0

□ **Line Control Register (LCR)**

Bit 0: Word Length Select Bit 0 (WLS0)

Bit 1: Word Length Select Bit 1 (WLS1)

WLS1	WLS0	Word Length
0	0	5 Bits
0	1	6 Bits
1	0	7 Bits
1	1	8 Bits

Bit 2: Number of Stop Bit (STB)

Bit 3: Parity Enable (PEN)

Bit 4: Even Parity Select (EPS)

Bit 5: Stick Parity

Bit 6: Set Break

Bit 7: Divisor Latch Access Bit (DLAB)

❑ **MODEM Control Register (MCR)**

Bit 0: Data Terminal Ready (DTR)

Bit 1: Request to Send (RTS)

Bit 2: Out 1 (OUT 1)

Bit 3: Out 2 (OUT 2)

Bit 4: Loop

Bit 5: Must be 0

Bit 6: Must be 0

Bit 7: Must be 0

❑ **Line Status Register (LSR)**

Bit 0: Data Ready (DR)

Bit 1: Overrun Error (OR)

Bit 2: Parity Error (PE)

Bit 3: Framing Error (FE)

Bit 4: Break Interrupt (BI)

Bit 5: Transmitter Holding Register Empty (THRE)

Bit 6: Transmitter Shift Register Empty (TSRE)

Bit 7: Must be 0

❑ **MODEM Status Register (MSR)**

Bit 0: Delta Clear to Send (DCTS)

Bit 1: Delta Data Set Ready (DDSR)

Bit 2: Training Edge Ring Indicator (TERI)

Bit 3: Delta Receive Line Signal Detect (DSLSD)



Bit 4: Clear to Send (CTS)

Bit 5: Data Set Ready (DSR)

Bit 6: Ring Indicator (RI)

Bit 7: Received Line Signal Detect (RSLD)

□ **Divisor Latch (LS, MS)**

	LS	MS
Bit 0:	Bit 0	Bit 8
Bit 1:	Bit 1	Bit 9
Bit 2:	Bit 2	Bit 10
Bit 3:	Bit 3	Bit 11
Bit 4:	Bit 4	Bit 12
Bit 5:	Bit 5	Bit 13
Bit 6:	Bit 6	Bit 14
Bit 7:	Bit 7	Bit 15

Desired Baud Rate	Divisor Used to Generate 16x Clock
300	384
600	192
1200	96
1800	64
2400	48
3600	32
4800	24
9600	12
14400	8
19200	6
28800	4
38400	3
57600	2
115200	1

## Appendix

### Dimension

a. FX5326

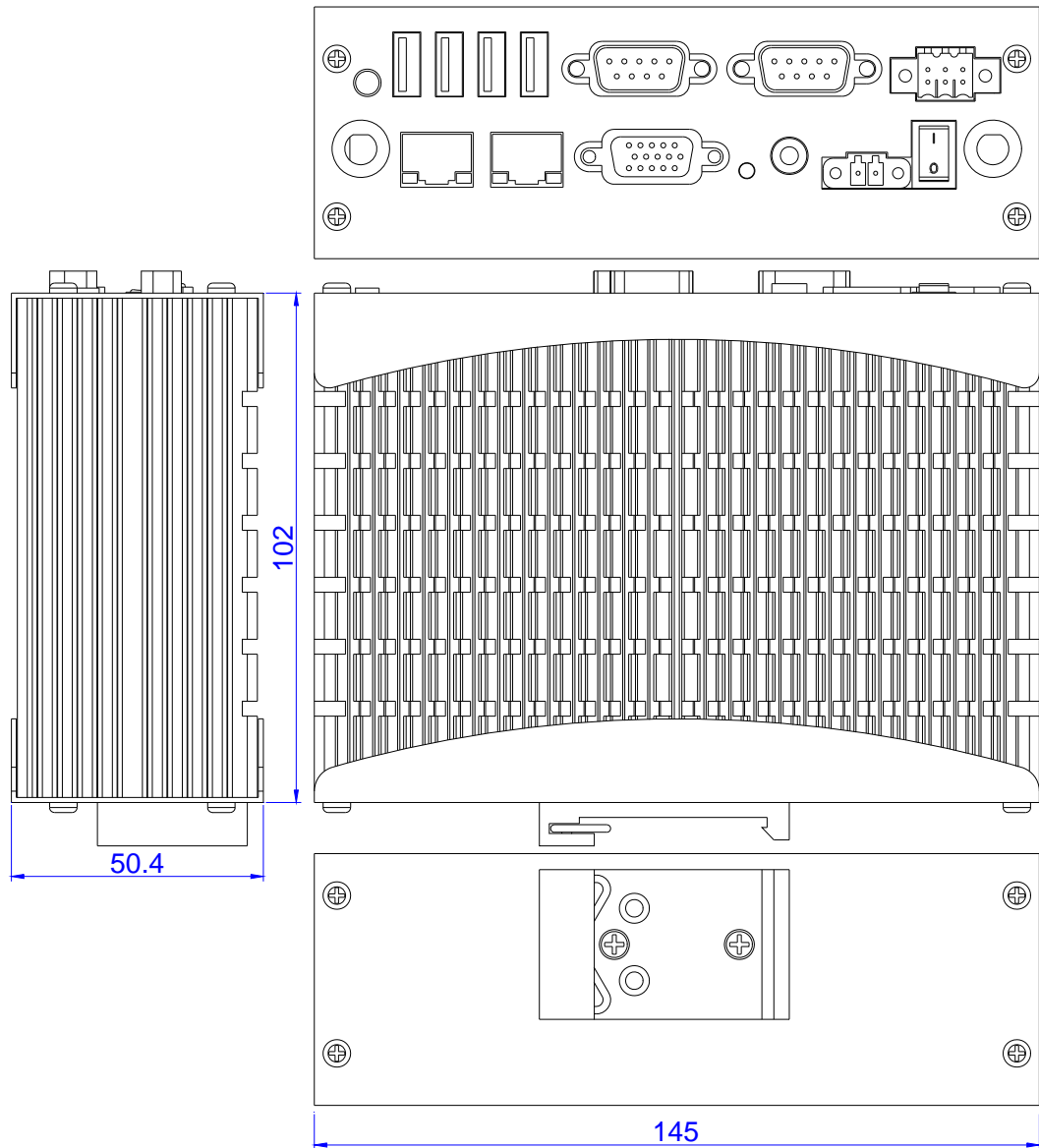

b. FX5326- DIN-Rail

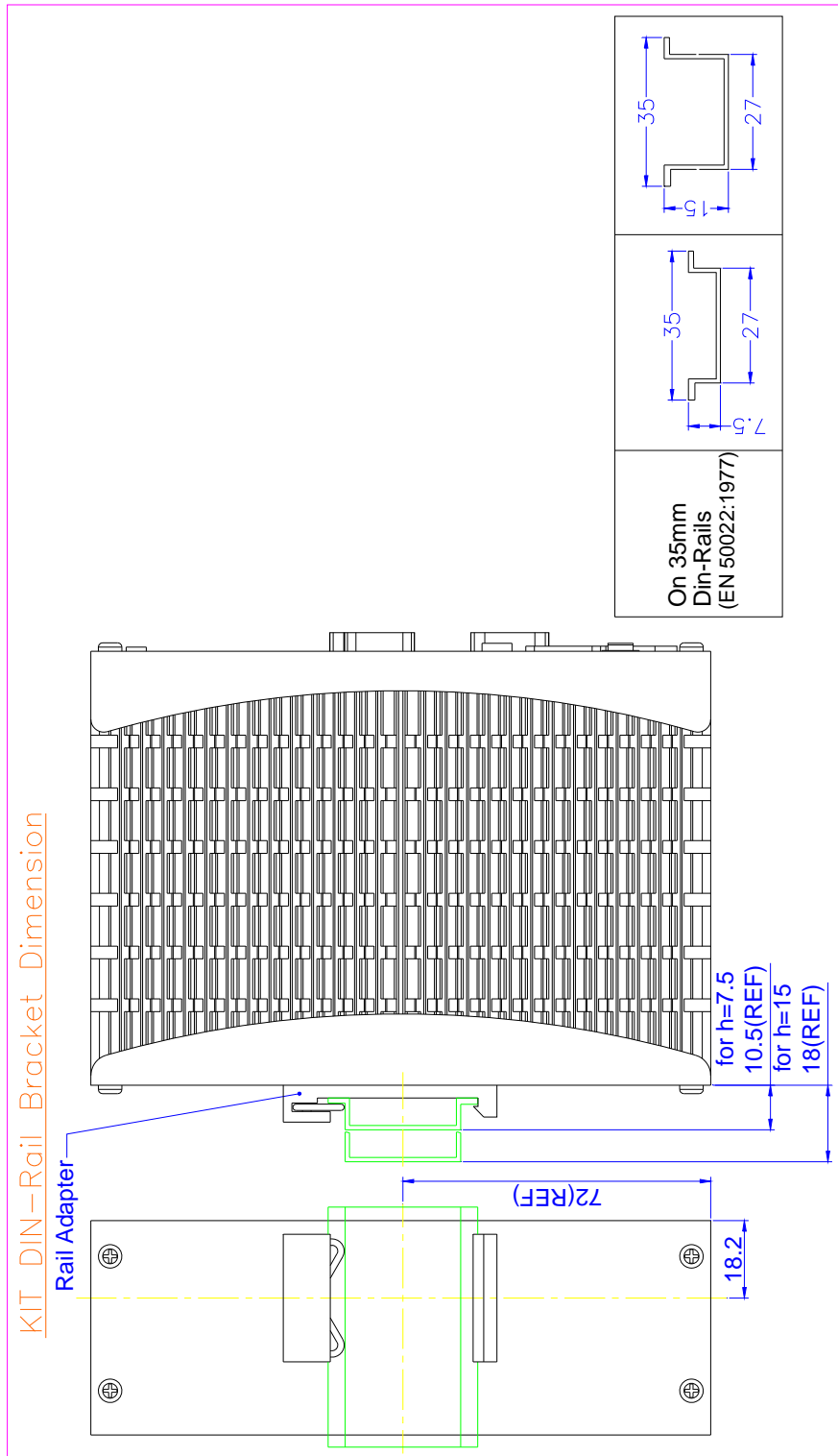

c. FX5326- 5311K1

