

FabiaTech Corporation

IPC Solution

Website: <http://www.FabiaTech.com>

Email: [support@FabiaTech.com](mailto:support@FabiaTech.com)

**Small Cube System**  
**Fanless Series**  
**FX5506 User's Manual**

---

MAY 2009  
Version: 1.0  
Part Number: FX5506

## Copyright

Copyright © 2009 FabiaTech Corporation, The content of this publication may not be reproduced in any part or as a whole, transcribed, stored in a retrieval system, translated into any language, or transcribed in any form or by any means, electronic, mechanical, and magnetic... or otherwise without the prior written permission of FabiaTech Corporation.

## Disclaimer

FabiaTech makes no representation of warranties with respect to the contents of this publication. In an effort to continuously improve the product and add features, FabiaTech reserves the right to revise the publication or change specifications contained in it from time to time without prior notice of any kind from time to time.

FabiaTech shall not be reliable for technical or editorial errors or omissions, which may occur in this document. FabiaTech shall not be reliable for any indirect, special, incidental or consequential damages resulting from the furnishing, performance, or use of this document.

## Trademarks

Trademarks, brand names and products names mentioned in this publication are used for identification purpose only and are the properties of their respective owners.

## Technical Support

If you have problems or difficulties in using the system or setting up the relevant devices, and software that are not explained in this manual, please contact our service engineer for service, or send email to [support@FabiaTech.com](mailto:support@FabiaTech.com).

## Returning Your Board For Service & Technical Support

If your board requires servicing, contact the dealer from whom you purchased the product for service information. You can help assure efficient servicing of your product by following these guidelines:

- ❑ A list of your name, address, telephone, facsimile number, or email address where you may be reached during the day
- ❑ Description of you peripheral attachments
- ❑ Description of your software (operating system, version, application software, etc.) and BIOS configuration
- ❑ Description of the symptoms (Extract wording any message)

For updated BIOS, drivers, manuals, or product information, please visit us at [www.FabiaTech.com](http://www.FabiaTech.com)

# Table of Contents

<b>FX5506 User's Manual</b> .....	<b>i</b>
<b>Chapter 1 Introducing the FX5506 System</b> .....	<b>1</b>
Overview.....	1
Series Comparison Table .....	2
Layout.....	3
Specifications.....	4
Packing List .....	5
<b>Chapter 2 Hardware Installation</b> .....	<b>7</b>
Before Installation .....	7
Removing Covers –Installing Hardware.....	8
a. Unscrew Bottom cover .....	8
b. Installing Memory .....	8
c. Installing PCIe Mini Card Module .....	9
d. Installing Hard Disk .....	10
e. Installing Compact Flash .....	11
f. Installing the universal fixers on FX5506.....	12
LED Indicators (On the Front Panel).....	13
I/O Peripheral Connectors .....	13
Connecting the DC Power and Power Switch .....	15
<b>Chapter 3 BIOS Setup</b> .....	<b>17</b>
Overview.....	17
BIOS Functions .....	18
Keyboard Convention .....	19
Main Setup .....	20
System Memory .....	20
System Date & Time Setup.....	20
Advanced Setup.....	21
CPU Configuration.....	21
IDE Configuration.....	22
ATA/IDE Configuration.....	22
SATA-0<1>/IDE Secondary Master/Slave.....	23

Hard Disk Write Protect .....	24
IDE Detect Time Out (Sec.) .....	24
ATA(PI) 80 Pin Cable Detection .....	24
SuperIO Chipset - Configuration WIN627 Super IO Chipset .....	25
KBC Clock Rate Selection .....	25
Serial Port 1 Address .....	25
Serial Port 2 Address .....	26
Hardware Health Configuration .....	26
APM Configuration .....	27
Power Management/APM .....	27
Video Power Down Mode .....	27
Hard Disk Power Down Mode .....	28
Suspend Time Out (Minute) .....	28
USB Configuration .....	28
Legacy USB Support .....	29
USB 2.0 Controller .....	29
USB 2.0 Controller Mode .....	29
BIOS ECHI Hand-Off .....	29
PCIPnP Setup .....	30
Clean NVRAM .....	30
Plug and Plug Aware O/S .....	30
PCI Latency Timer .....	31
Palette Snoop .....	31
PCI IDE BusMaster .....	31
IRQ 3 –15 .....	31
DMA Channel 0 – 7 .....	32
Boot Setup .....	33
Boot Setting Configuration .....	34
Quick Boot .....	34
Boot Up Num-Lock .....	34
PS/2 Mouse Support .....	35
Hit 'DEL' Message Display .....	35

Boot Device .....	36
First /Second /Third Hard Disk Boot Device .....	36
Hard Disk Drives .....	37
Removable Drives .....	37
CD/DVD Disk Drives .....	38
Security setup .....	39
Clean User Password .....	40
Password Check .....	40
Boot Sector Virus Protection .....	40
Chipset Setup .....	41
Northbridge Configuration .....	42
DRAM Frequency .....	42
Configure DRAM Timing by SPD .....	42
Internal Graphics Mode Select .....	43
Graphics Aperture Size .....	43
Video Function Configuration .....	43
Southbridge Configuration .....	44
USB Function .....	44
USB 2.0 Controller .....	44
Audio Controller .....	45
On Board G-LAN1/G-LAN2 Controller .....	45
G-LAN Boot ROM Controller .....	45
<b>Chapter 4 Software Installation .....</b>	<b>47</b>
System Driver .....	47
WIN 2000/2003/XP/Vista-x64 Driver .....	47
VGA Driver .....	48
WIN 2000/2003/XP/Vista-x64 Driver .....	48
Audio Driver .....	48
WIN 2000/2003/XP/Vista-x64 Driver .....	48
LAN Driver (Intel 82573L) .....	49
WIN 2000/2003/XP/Vista-x64 Driver .....	49
BIOS Flash Utility .....	49
Watchdog Timer .....	50

Watchdog Timer Setting .....	51
Watchdog Timer Enabled .....	52
Watchdog Timer Trigger .....	52
Watchdog Timer Disabled .....	53
Programming RS-485 .....	54
Initialize COM port .....	54
Send out one character (Transmit) .....	55
Send out one block data (Transmit – the data more than two characters) ..	55
Receive data .....	55
Basic Language Example .....	55
<b>Chapter 5 Technical Reference .....</b>	<b>57</b>
Trouble Shooting for Post Beep and Error Messages .....	57
POST BEEP .....	57
CMOS BATTERY FAILURE .....	57
CMOS CHECKSUM ERROR .....	58
DISK BOOT FAILURE .....	58
DISKETTE DRIVES OR TYPES MISMATCH ERROR .....	58
ERROR ENCOUNTERED INITIALIZING HARD DRIVE .....	58
ERROR INITIALIZING HARD DISK CONTROLLER .....	58
FLOPPY DISK CONTROLLER ERROR OR NO CONTROLLER PRESENT .....	58
KEYBOARD ERROR OR NO KEYBOARD PRESENT .....	58
MEMORY ADDRESS ERROR .....	59
MEMORY SIZE HAS CHANGED .....	59
MEMORY VERIFYING ERROR .....	59
OFFENDING ADDRESS MISSING .....	59
REBOOT ERROR .....	59
SYSTEM HALTED .....	59
Technical Reference .....	60
Physical and Environmental .....	60
Real-Time Clock and Non-Volatile RAM .....	60
CMOS RAM Map .....	62
I/O Port Address Map .....	63
Interrupt Request Lines (IRQ) .....	64

DMA Channel Map .....	65
DMA Controller 2.....	65
Serial Ports .....	66
Receiver Buffer Register (RBR) .....	66
Transmitter Holding Register (THR) .....	66
Interrupt Enable Register (IER) .....	66
Interrupt Identification Register (IIR) .....	67
Line Control Register (LCR) .....	67
MODEM Control Register (MCR) .....	68
Line Status Register (LSR) .....	68
MODEM Status Register (MSR) .....	68
Divisor Latch (LS, MS) .....	69
<b>Appendix.....</b>	<b>70</b>
Dimension .....	70



## Chapter 1 Introducing the FX5506 System

### Overview

The FX5506 is an embedded system with low-power CPU module inside. This user's manual provides information on the physical features, installation, and BIOS setup of the FX5506.

Built to unleash the total potential of the Celeron-M Processor, Able to support Celeron-M1.06G/1M FSB533 CPU, this system supports two 10/100/1000M Base-TX LAN ports, 1GB DDR2-RAM, PCIe Mini Card connector for GPRS/GPS modules, Four USB2.0 ports, and DVI port.

Each FX5506 has two ports for I/O communications. Two RS-232C ports are available.

The FX5506 is perfect for ATM machines, KIOSK, point-of-sales/point-of-information, gaming and infotainment, measurement technology, lotteries, banking and Thin Client and small Embedded Control. The unit is only 148.0mm (D) X203.0mm (W) X55mm (H).

## Series Comparison Table

Model	FX5506
Processor	Intel Celeron-M C-M1.06G/1M FSB533 BGA479
<i>N+S-Chipset</i>	<i>QG82945GME+NH82801GBM</i>
<i>Memory</i> 200 Pin-DIMM*1(Max.)	<i>DDR2 400/533/667</i> <i>1GB/2GB</i>
<i>Storage HDD</i>	<i>One CF and One SATA</i>
DVI	Yes
<i>Watchdog Timer</i>	<i>Yes</i>
<i>Multi I/O</i>	<i>Two RS-232</i>
<i>USB 2.0</i>	<i>Four USB ports</i>
<i>Audio</i>	<i>Ear-Phone/Line-In And MIC-In</i>
<i>RJ45 LAN port</i>	<i>Two Intel 82573L 10/100/1000Mbps</i>
PCIe Mini Card	One
Operating Temperature	0~+50°C (32~122°F)
Dimensions (Unit: mm)	148(D) x 203(W) X 55(H)

## Layout

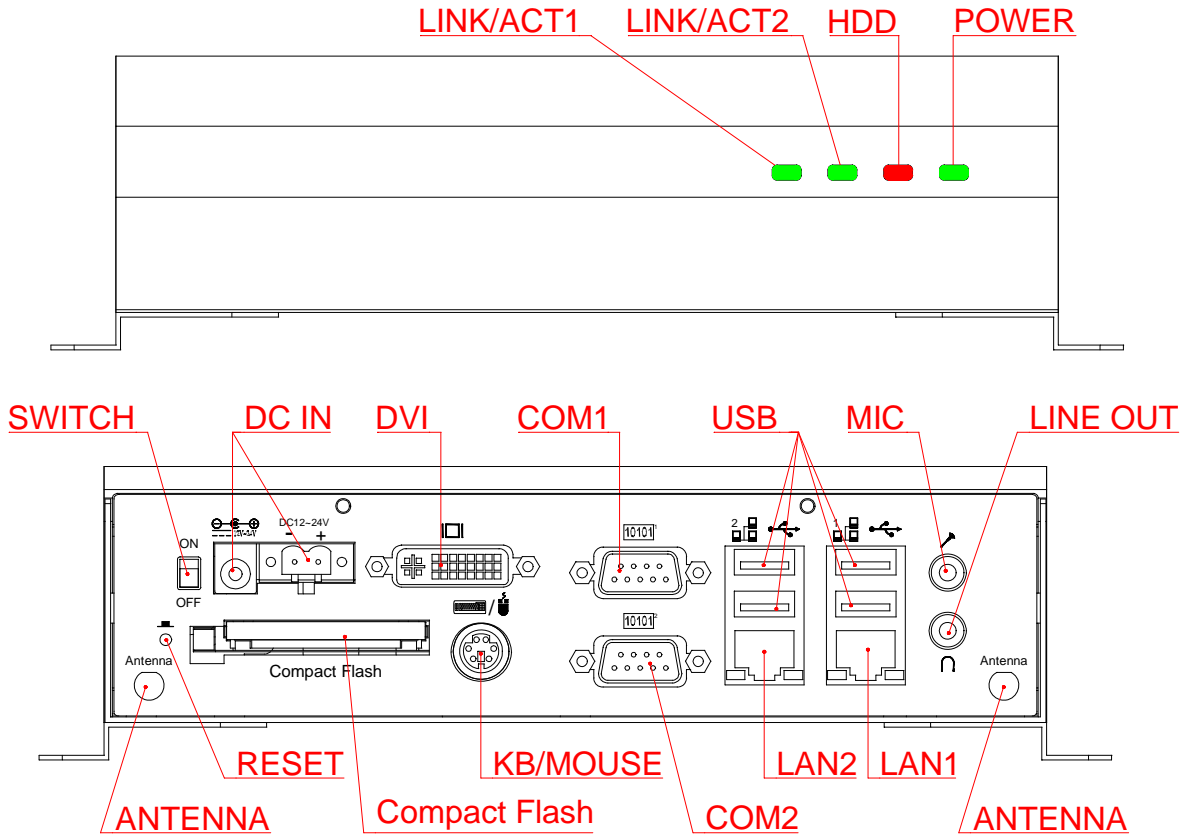

## Specifications

### ❑ *Processor Board –*

Intel Low Power Celeron-M 1.06GHz CPU with 1GB DDR2-RAM.

### ❑ *I/O Outlets –*

Two 10/100/1000 base-TX Ethernet LAN ports.

Four USB ports (2.0) and two RS-232 serial ports.

One DVI (Including CRT) and one PS/2 compatible keyboard and mouse interfaces.

One Earphone-Out and Microphone-Input connectors.

One PCIe Mini card socket modules, especially for WLAN/GPRS module.

One DC-In plug connector and one terminal block with power switch.

One power LED, One HDD/CF access LED, and two LAN LED's.

One push button reset switch.

### ❑ *Storage Bay-*

Compact Flash socket for Compact Flash modules or MicroDrives.

One 2.5" SATA hard disk space

### ❑ *Power requirement –*

+12 ~ +24V DC, 2.23A maximum (1.42A typical) with 19V input voltage.

### *Dimensions -*

148.0mm(D) x 203.0mm(W) x 55.0mm(H)

## Packing List

Upon receiving the package, verify the following things. Should any of the mentioned happens, contact us for immediate service.

- Unpack and inspect the FX5506 package for possible damage that may occur during the delivery process.
- Verify the accessories in the package according to the packing list and see if there is anything missing or incorrect package is included.
- If the cable(s) you use to install the FX5506 is not supplied from us, please make sure the specification of the cable(s) is compatible with the FX5506 system.

**Note:** after you install the FX5506, it is recommended that you keep the diskette or CD that contains drivers and document files, and keep the document copies, or unused cables in the carton for future use.

The following lists the accessories that may be included in your FX5506 package. Some accessories are optional items that are only shipped upon order.

- One FX5506 embedded system.
- One AC to DC power adapter and 1 AC power code.
- One Y cable (3-end) PS2 Keyboard plus mouse port adapter Cable.
- One DVI to CRT adapter kit. (Optional)
- One pack of 2.5" SATA hard disk installation kit with fixed screws.
- One 2-pin apartable terminal block.
- One FX5501k1 universal fixers and 4 screws.(Optional)
- One FX5501k2 universal fixers and 4 screws.(Optional)
- One FX5504k1 universal fixers and 2 screws.(Optional)
- One compact disc includes software utility and manual.



## Chapter 2 Hardware Installation

This chapter introduces the system connectors & jumper settings, and guides you to apply them for field application.

### Before Installation

Before you install the system, make sure you follow the following descriptions.

1. Before removing the cover, shut down the operation System and disconnect power switch to off and unplug AC-to DC Adapter cable.
2. Install any connector, Compact Flash, and hard disk be sure that the power is disconnected or power switch to off from the system. If not, this may damage the system.
3. The ESD (Electricity Static Discharge) may be created from human body that touches the board. It may do damage to the board circuit.

□ **Removing Covers -Installing Hardware**

If you are installing hardware option, you can remove the bottom cover. The following figure will guide you how to install SATA 2.5" HDD inside, Compact Flash modules, PCIe mini card module, and DDR2-RAM module the FX5506. (Please see the spots circled.)

➤ **a. Unscrew Bottom cover**

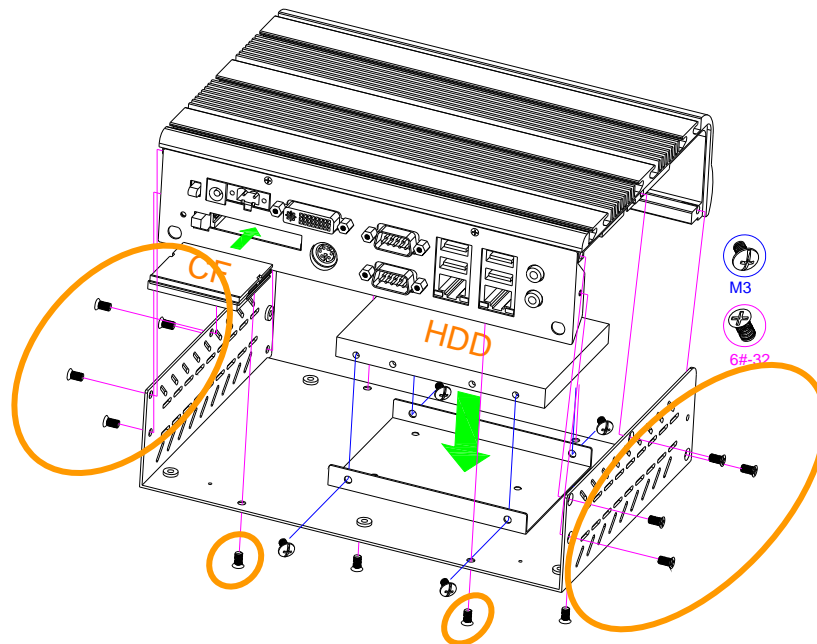

➤ **b. Installing Memory**

You may extend additional memory to FX5506, See as following figure. The So-DIMM socket supports 512MB to 2GB of DDR2 RAM modules.

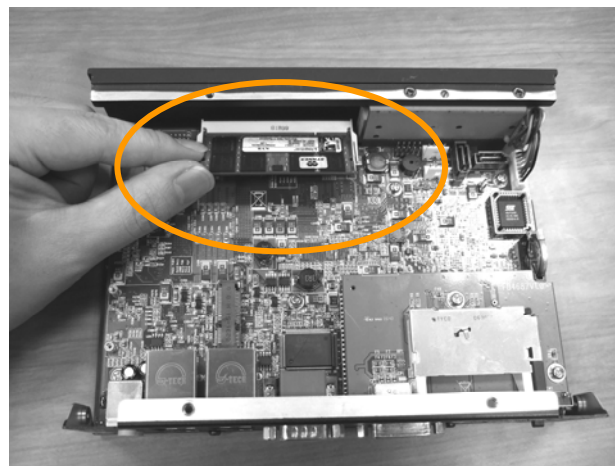

➤ **c. Installing PCIe Mini Card Module**

You may extend additional PCIe mini card module and SIM card to FX5506. Connect the antenna cable from backside antenna hole to GPRS module and installing the auxiliary board for SIM card. See as following figure and rear pictures.

❖ *c1. Installing PCIe Mini Card*

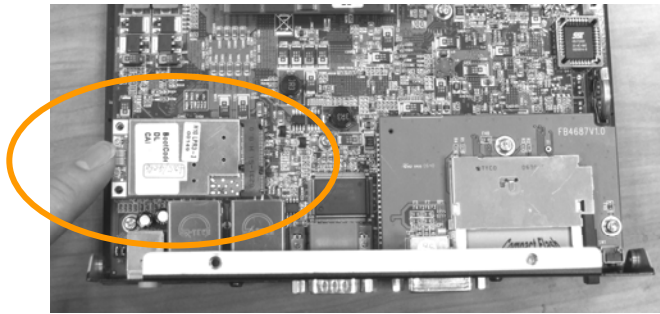

❖ *c2. Fasten Screw and Connect Antenna to the PCIe Mini Card*

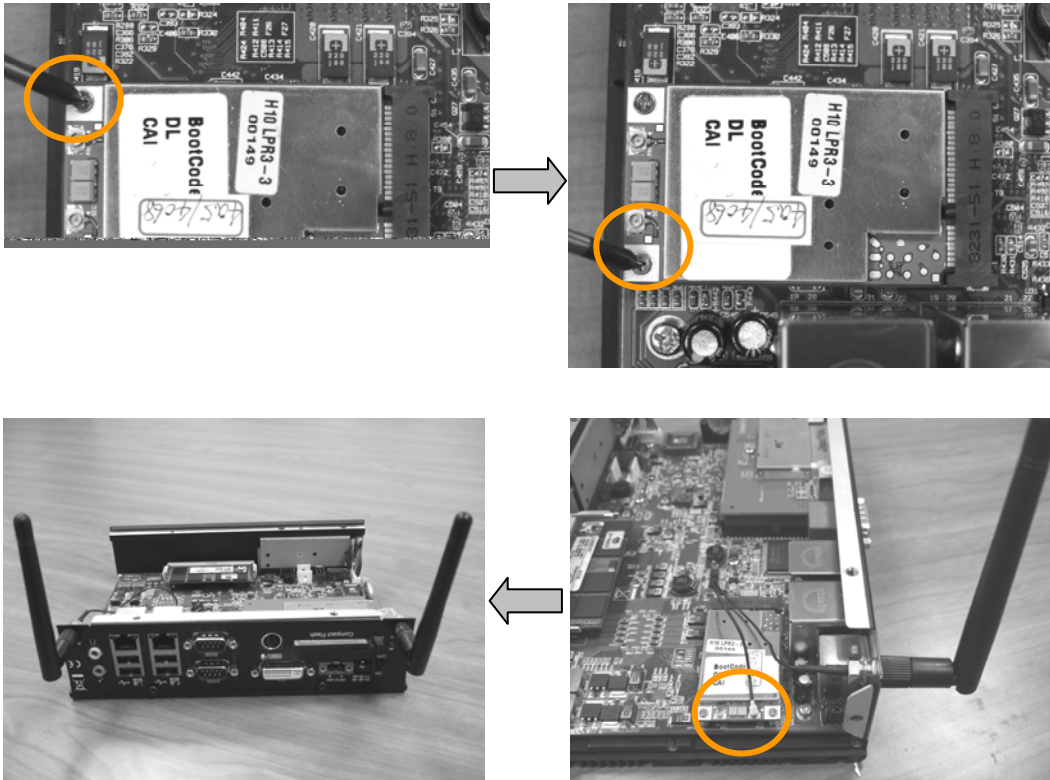

◇ **c3. Installing auxiliary board for GPRS Modules**

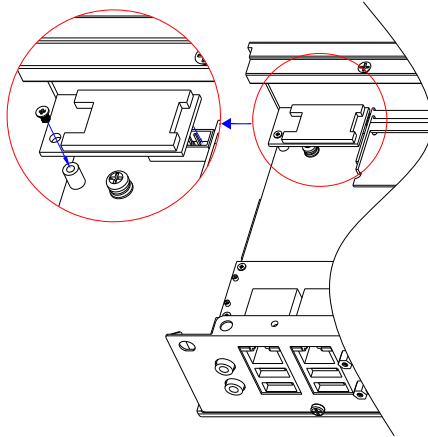

**Note:**

1. When installing PCIe GPRS Mini card on FX5506 system these is need the installing the SIM Card to auxiliary board.
2. Open the cover with auxiliary board then insert SIM card into the SIM card hold. Make sure that the SIM card is properly inserted and that golden contact area on the card is facing downwards.

➤ **d. Installing Hard Disk**

Fasten screws up the Hard disk device to bottom inside HDD metal frame and connect the SATA HDD cable and power cable. See as following figure and rear pictures.

◇ **d1. Fasten screw the SATA HDD**

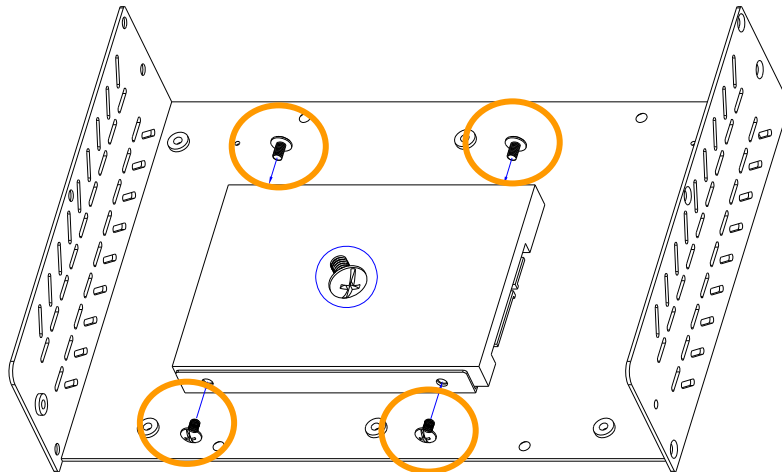

❖ *d2. Installing SATA Cable*

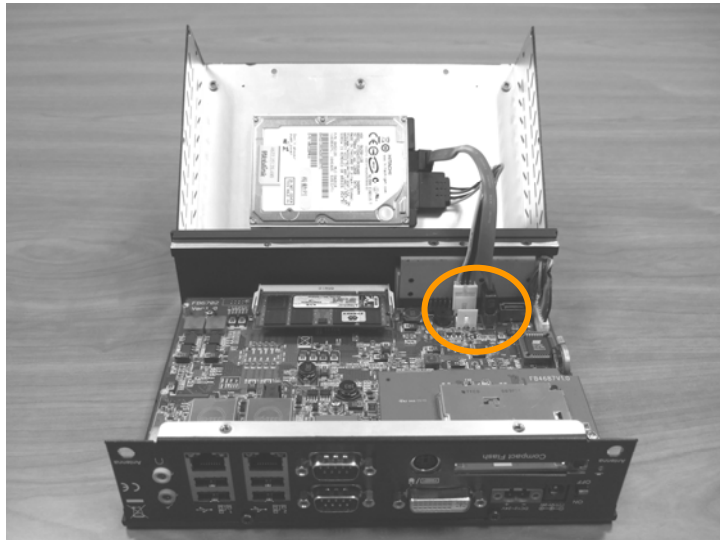

**Note:** Be careful with the pin orientation when installing connectors and the cables. CN3 and CN4 are used to connect a SATA 2.5" HDD with included SATA cable, CN2 and CN5 is for SATA power connector. (The CN2/CN5 support +5V Voltage only)

➤ *e. Installing Compact Flash*



**Note:** The Compact Flash socket (on the FX5506) supports 3.3V Compact Flash and Micro Drives.

➤ **f. Installing the universal fixers on FX5506**

Please refer to the down side figure for installing the FX5506 with universal fixers.

a. FX5501K1 universal fixers.

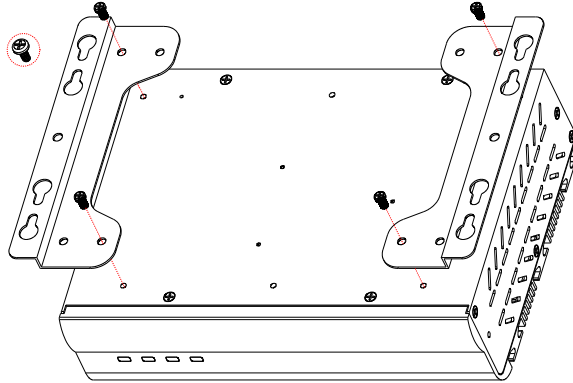

b. FX5501K2 universal fixers.

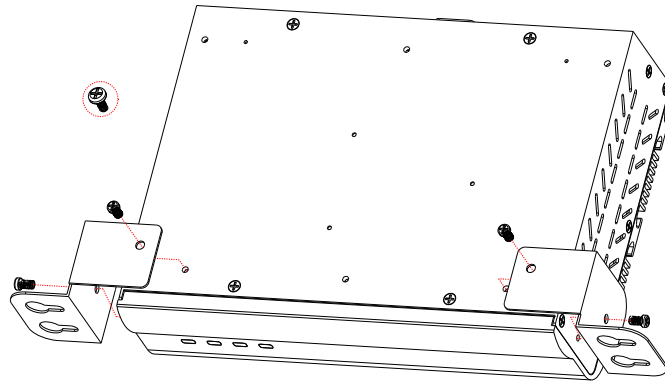

c. FX5504K1 universal fixers.

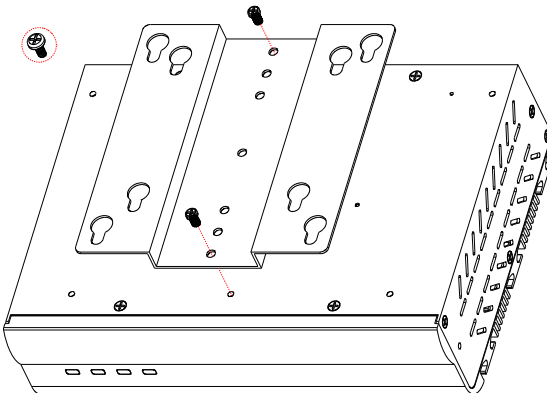

□ **LED Indicators (On the Front Panel)**

The Power and HDD LED's has two distinctive statuses: Off for inactive operation and blinking light for activity. And the 2 LED's for LAN ports. The LAN1 and LAN2 LED's (Green) indicate on-line/access status of LAN1 and LAN2 respectively.

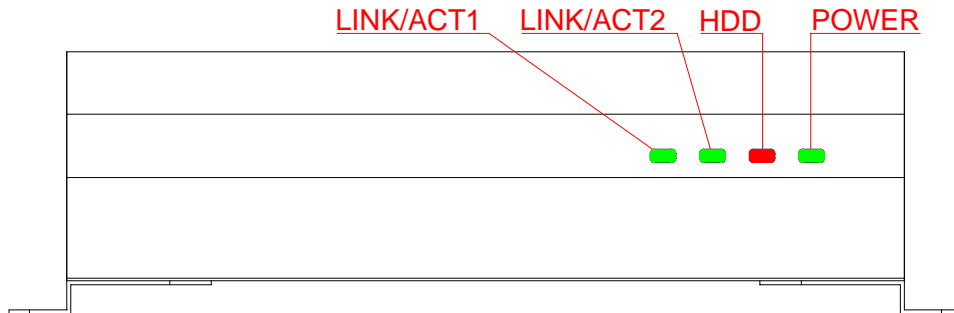

□ **I/O Peripheral Connectors**

View from the back side, If you are connecting the monitor, keyboard, mouse, LAN, audio, COM and USB to the FX5506. See following figure and a side pictures.

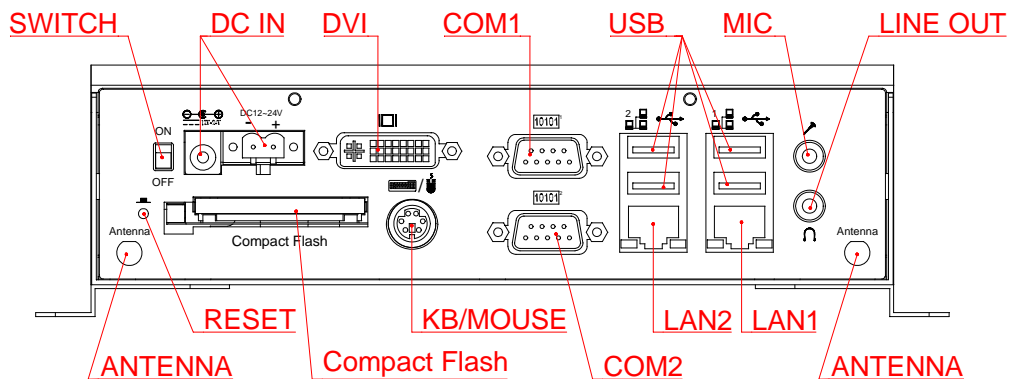

1. A DVI connector is provided for CRT signals and DVI signals.

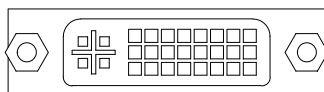
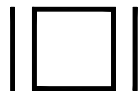

2. The connectors use the included adapter cable you can attach standard PS/2 type keyboard and mouse. Standard PS/2 keyboard can be plugged into this connector without any adapter cable. If PS/2 keyboard and mouse will be used simultaneously, a Y-type (3-terminal) adapter cable is needed.

**KB**

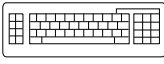

**MOUSE**



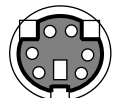

KB /Mouse	Description
1	Keyboard Data
2	Mouse Data
3	Ground
4	VCC
5	Keyboard Clock
6	Mouse Clock

3. COM ports

The DB9 (COM1/2) is standard serial port connector. The following tables show the signal connections of these connectors.

**COM**

10101

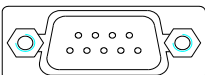

DB-9	RS-232 Signal
1	-DCD
6	-DSR
2	RXD
7	-RTS
3	-TXD
8	-CTS
4	-DTR
9	-RI
5	Ground
Case	Case Ground

4. LAN ports

The RJ45 connector with 2 LED's for WAN/LAN. The right side LED (orange) indicates data is being accessed and the left side LED (green) indicates on-line status. (On indicates on-line and off indicates off-line)

RJ45 connector

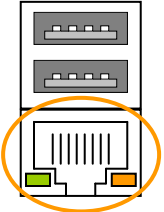

1      8

(Front View)

**LAN**

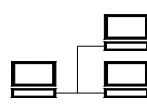

The following lists the pin assignment of RJ45.

LAN1/LAN2	Signal	LAN1/LAN2	Signal
1	TPTX+	5	TPTX1-
2	TPTX -	6	TPRX -
3	TPRX+	7	TPRX1+
4	TPTX1+	8	TPRX1-

## 5. USB Ports

The FX5506 supports a four port USB connector. Any USB device can be attached to USB ports with plug-and-play supported. The backside is USB # 1/2 and USB # 3/4.

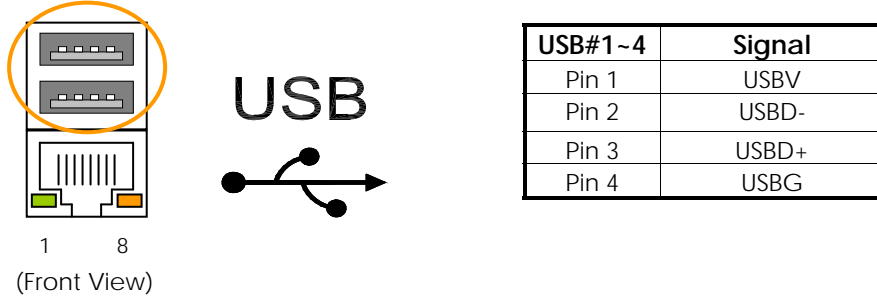

USB#1~4	Signal
Pin 1	USBV
Pin 2	USB D-
Pin 3	USB D+
Pin 4	USB G

1 8  
(Front View)

## 6. Connecting the Audio Microphone In/ EAR-Phone

Mic-In                      EAR-Phone

### □ Connecting the DC Power and Power Switch

Power is supplied through an external AC/DC power adapter or power DC In. Check the technical specification section for information about AC/DC power input voltage. See following figure and a side pictures.

#### 1. DC-Power Jack: Use External AC/DC power adapter

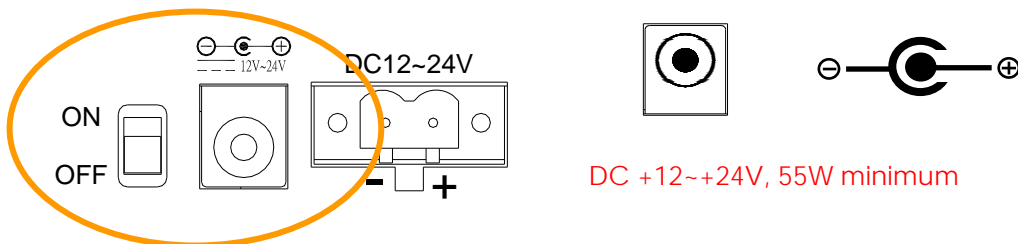

ON OFF

DC12~24V

DC +12~+24V, 55W minimum

Since the switch does include a power switch, plugging its power adapter into a power outlet then switch power to on, when you final installed system hardware device.

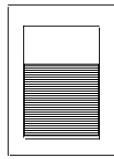

Off: Power Off

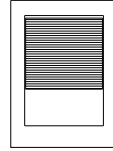

On: Power On

2. DC Power Connector: Use external 2-pin apartable terminal block.

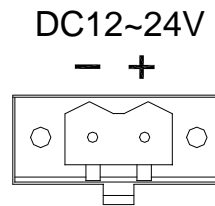
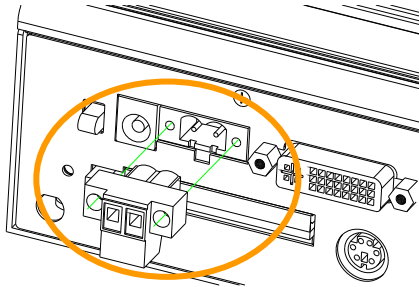

**Terminal Block**

3. The FX5506 has a push button switcher for system reset; Push and release the button will cause hardware reset of FX5506 and restart system booting.

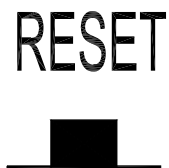

## Chapter 3 BIOS Setup

This chapter describes the BIOS setup.

### Overview

BIOS are a program located on a Flash memory chip on a circuit board. It is used to initialize and set up the I/O peripherals and interface cards of the system, which includes time, date, hard disk drive, the ISA bus and connected devices such as the video display, diskette drive, and the keyboard. This program will not be lost when you turn off the system.

The BIOS provides a menu-driven interface to the console subsystem. The console subsystem contains special software, called firmware that interacts directly with the hardware components and facilitates interaction between the system hardware and the operating system.

The BIOS default values ensure that the system will function at its normal capability. In the worst situation the user may have corrupted the original settings set by the manufacturer.

All the changes you make will be saved in the system RAM and will not be lost after power-off.

When you start the system, the BIOS will perform a self-diagnostics test called Power On Self Test (POST) for all the attached devices, accessories, and the system. Press the [Del] key to enter the BIOS Setup program, and then the main menu will show on the screen.

**Note:** Change the parameters when you fully understand their functions and subsequence.

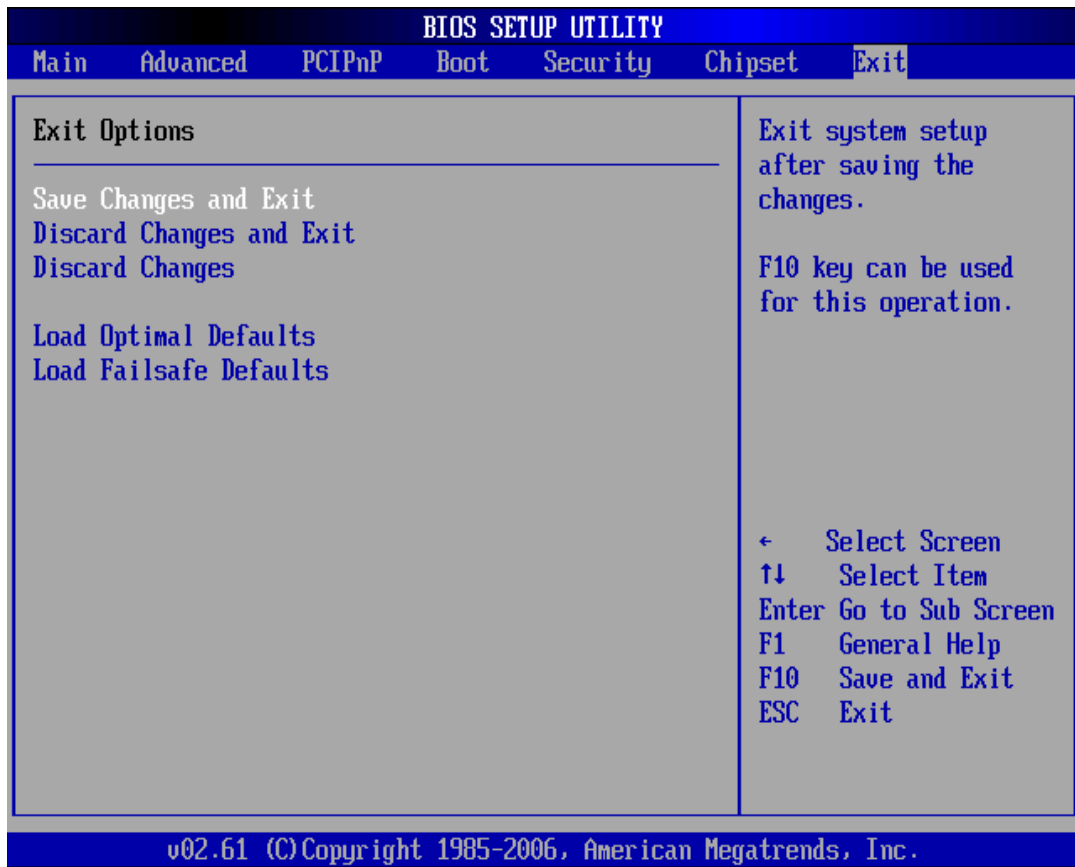

□ **BIOS Functions**

On the menu, you can perform the following functions

1. Main
2. Advanced
  - CPU Configuration
  - IDE Configuration
  - SuperIO Configuration
  - Hardware Health Configuration
  - APM Configuration
  - PCI Express Configuration
  - USB Configuration
3. PCIPnP
4. Boot
  - Boot Settings Configuration
  - Boot Device Priority
  - Hard Disk Drives
  - CD/DVD Drivers
5. Security
  - Change Supervisor Password
  - Change User Password
  - Clean User Password
  - Boot Sector Virus Protection

- 6. Chipset
  - NorthBridge Configuration
  - SouthBridge Configuration
- 7. Exit
  - Save Changes and Exit: Exit system setup after saving the changes.F10 key can be used for this operation.
  - Discard Changes and Exit: Exit system setup without saving any changes. ESC key can be used for this operation.
  - Discard Changes: Discard changes down so far any of the set questions. F7 key can be used this operation.
  - Load Optimized Default: to auto configure the system according to optimal setting with pre-defined values. This is also the factory default setting of the system when you receive the board.
  - Load Fail-Safe Default: to configure the system in fail-safe mode with predefined values.

### Keyboard Convention

On the BIOS, the following keys can be used to operate and manage the menu:

Item	Function
ESC	To exit the current menu or message
Page Up/Page Down	To select a parameter
F1	To display the help menu if you do not know the purpose or function of the item you are going to configure
F8	Fail-Safe Default
F9	Optimized Default
F10	Save and exit
UP/Down Arrow Keys	To go upward or downward to the desired item

## Main Setup

This section describes basic system hardware configuration, system clock setup and BIOS version information. If the CPU board is already installed in a working system, you will not need to select this option anymore.

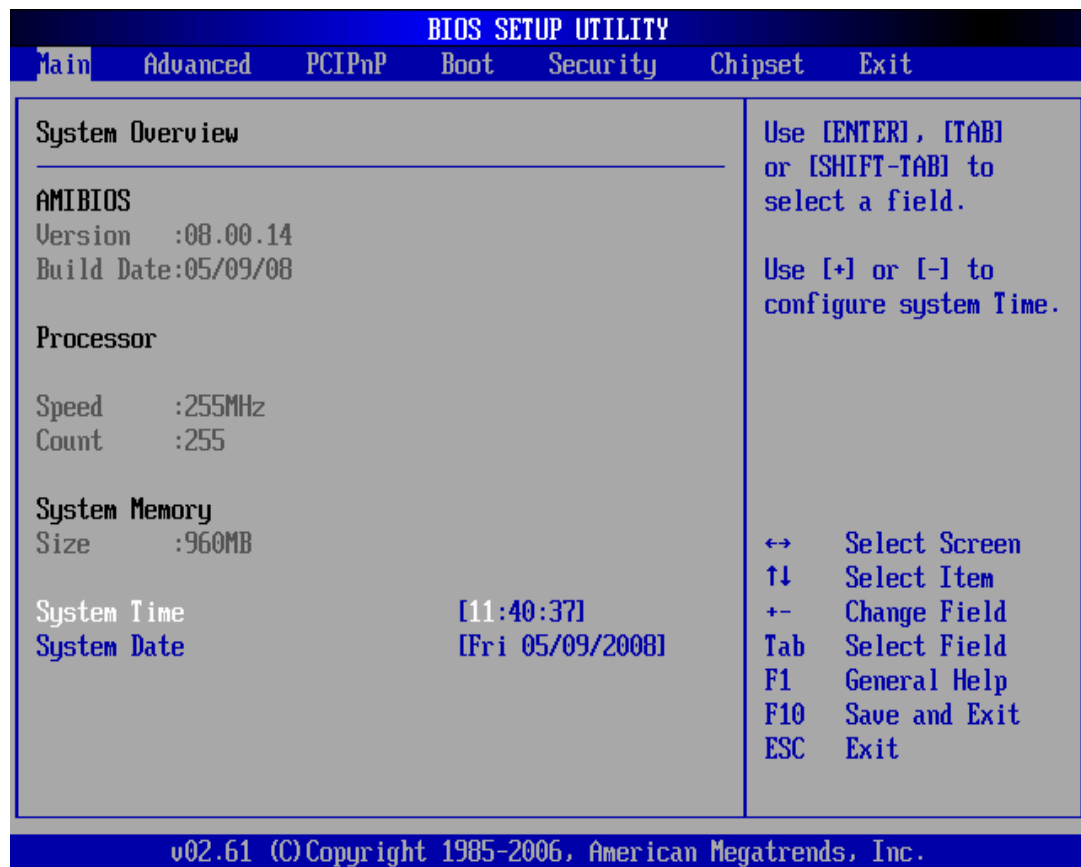

### ➤ System Memory

This option is display-only which is determined by POST (Power On Self Test) of the BIOS.

### ➤ System Date & Time Setup

Highlight the <Date> field and then press the [Page Up] / [Page Down] or [+]/ [-] keys to set the current date. Follow the month, day and year format.

Highlight the <Time> field and then press the [Page Up] / [Page Down] or [+]/ [-] keys to set the current date. Follow the hour, minute and second format.

The user can bypass the date and time prompts by creating an AUTOEXEC.BAT file. For information on how to create this file, please refer to the MS-DOS manual.

## Advanced Setup

Select the *Advanced* tab from the setup screen to enter the Advanced BIOS Setup screen. You can select any of the items in the left frame of the screen, such as SuperIO Configuration, to go to the sub menu for that item. You can display an Advanced BIOS Setup option by highlighting it using the <Arrow> keys. All Advanced BIOS Setup options are described in this section. The Advanced BIOS Setup screen is shown below. The sub menus are described on the following pages

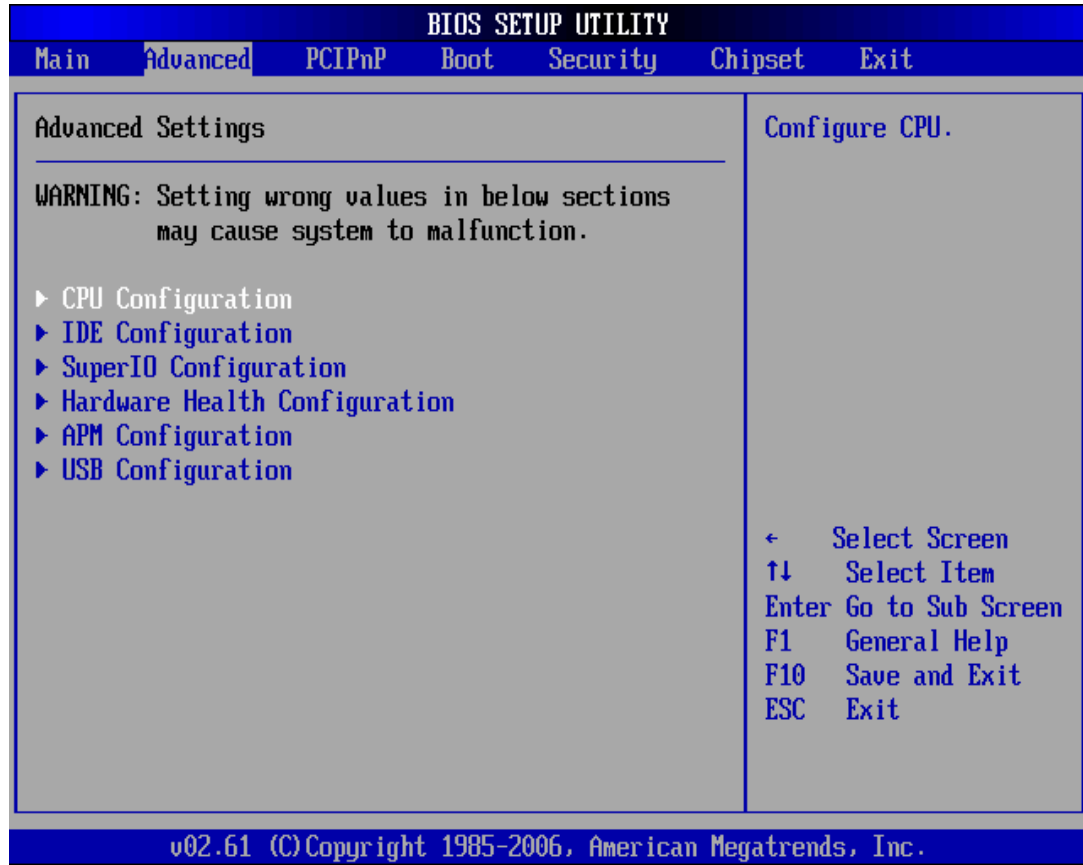

### ➤ CPU Configuration

You can use this screen to select options for the CPU information. Use the up and down <Arrow> keys to select an item. Use the <Plus> and <Minus> keys to change the value of the selected option.

**Note:** The CPU Configuration setup screen varies depending on the installed processor.

➤ **IDE Configuration**

You can use this screen to select options for the IDE Configuration Settings. Use the up and down <Arrow> keys to select an item. Use the <Plus> and <Minus> keys to change the value of the selected option. A description of the selected item appears on the right side of the screen. The settings are described on the following pages. An example of the *IDE Configuration* screen is shown below.

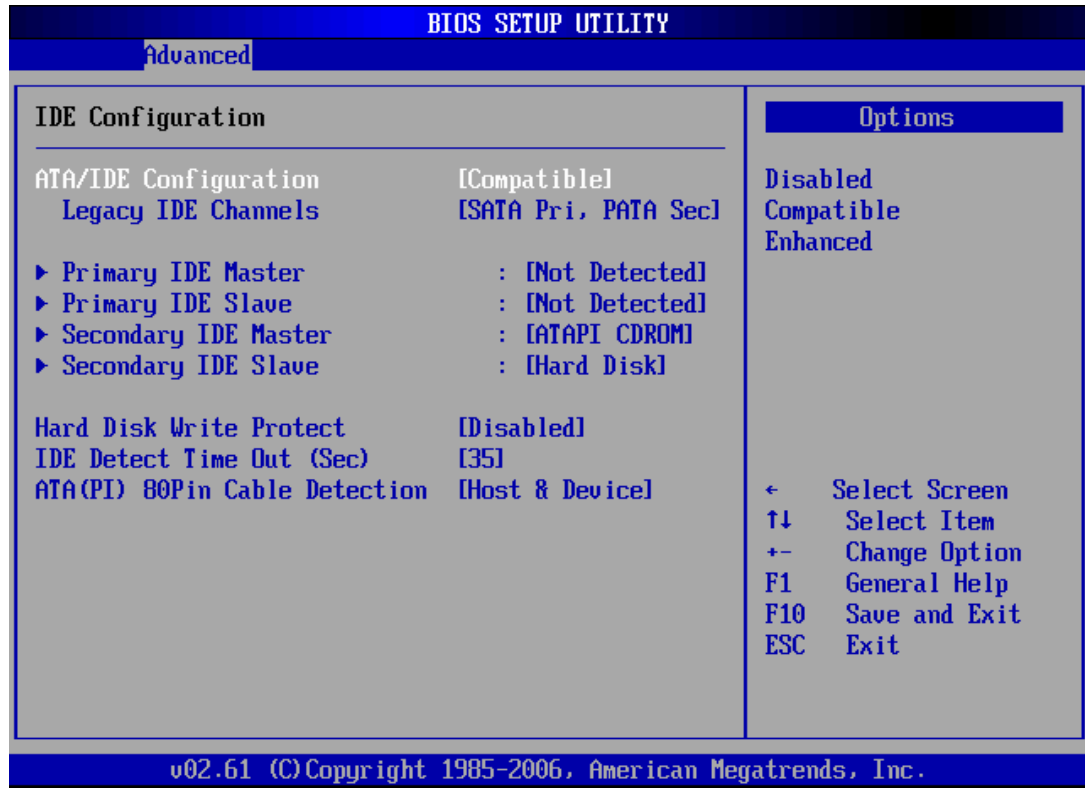

➤ **ATA/IDE Configuration**

This item specifies the ATA/IDE channels used by the onboard PATA/SATA IDE controller depend on the operation system (OS) that installed. When installed DOS, WIN95/98/ME Will can set to compatible mode. And set to Enhanced mode if you are using native OS, like Windows-XP/2k

**Available Options:** Disabled, Compatible, and Enhanced

**Default setting:** Compatible

■ **Legacy IDE Channels**

This field is when set to Compatible mode; you can select the SATA Only,SATA Pri\_ PATA Sec or PATA Only.

**Available Options:** STAT Only, SATA Pri, PATA\_Sec, and PATA Only

**Default setting:** SATA Pri, PATA\_Sec

➤ **SATA-0<1>/IDE Secondary Master/Slave**

IDE hard drive controllers can support up to two separate hard drives. These drives have a master/slave relationship, which is determined by the cabling configuration used to attach them to the controller. Your system supports one IDE controller – a primary – so you have the ability to install up to two separate hard disks.

**LBA/Large Mode**

LBA (Logical Block Addressing) is a method of addressing data on a disk drive. In LBA mode, the maximum drive capacity is 137 GB. The Optimal and Fail-Safe default setting is *Auto*

**Hard Disk Type**

The BIOS supports various types for user settings, The BIOS supports <Pri Master>, <Pri Slave>, so the user can install up to two hard disks. For the master and slave jumpers, please refer to the hard disk's installation descriptions and the hard disk jumper settings.

You can select <AUTO> under the <TYPE> and <MODE> fields. This will enable auto detection of your IDE drives during boot up. This will allow you to change your hard drives (with the power off) and then power on without having to reconfigure your hard drive type. If you use older hard disk drives, which do not support this feature, then you must configure the hard disk drive in the standard method as described above by the <USER> option.

**PIO MODE**

PIO means Programmed Input/Output. Rather than have the BIOS issue a series of commands to affect a transfer to or from the disk drive, PIO allows the BIOS to tell the controller what it wants and then let the controller and the CPU perform the complete task by them. This is simpler and more efficient (and faster). Your system supports five modes, numbered from 0 to 4, which primarily differ in timing. When Auto is selected, the BIOS will select the best available mode.

**BLOCK (Multi-Sector Transfer)**

This option allows your hard disk controller to use the fast block mode to transfer data to and from your hard disk drive (HDD).

**S.M.A.R.T**

This field is used to activate the S.M.A.R.T (System Management and Reporting Technologies) function for S.M.A.R.T HDD drives. This function requires an application that can give S.M.A.R.T message.

**32 Bit Data Transfer**

This option sets the 32-bit data transfer option. The Optimal and Fail-Safe default setting is *Enabled*.

➤ **Hard Disk Write Protect**

Set this option to protect the hard disk drive from being overwritten. The Optimal and Fail-Safe default setting is *Disabled*.

**Available Options:** Disabled, Enabled

**Default setting:** Disabled

➤ **IDE Detect Time Out (Sec.)**

Set this option to stop the AMIBIOS from searching for IDE devices within the specified number of seconds. Basically, this allows you to fine-tune the settings to allow for faster boot times. Adjust this setting until a suitable timing that can detect all IDE disk drives attached is found.

**Available Options:** 0, 5, 10, 15, 20, 25, 30, and 35

**Default setting:** 35

➤ **ATA(PI) 80 Pin Cable Detection**

Set this option to select the method used to detect the ATA (PI) 80 pin cable. The use of an 80-conductor ATA cable is mandatory for running Ultra ATA/66, Ultra ATA/100 and Ultra ATA/133 IDE hard disk drives. The standard 40-conductor ATA cable cannot handle the higher speeds.

**Available options:** Host & Device, Host, and Device

**Default setting:** Host & Device

➤ **SuperIO Chipset - Configuration WIN627 Super IO Chipset**

This section describes the function of Super I/O settings.

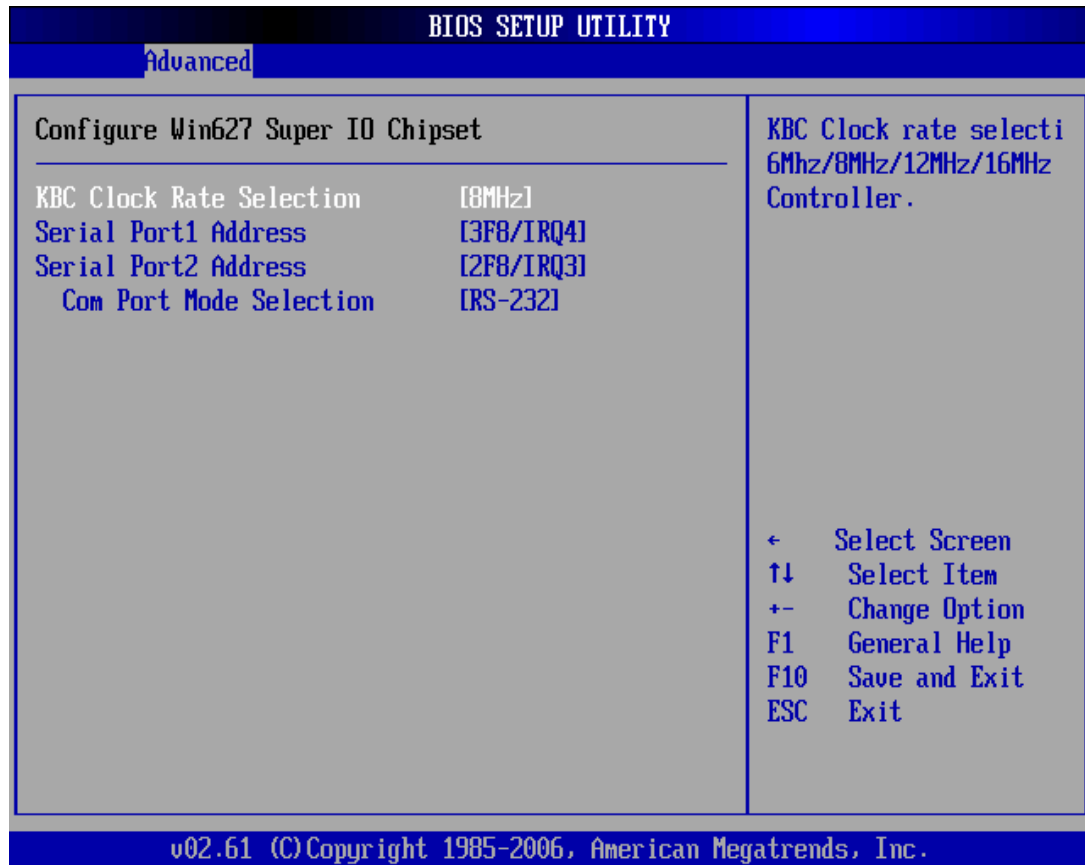

➤ **KBC Clock Rate Selection**

This field is select Keyboard clock rate selecting 6MHz/8MHz/12MHz/16MHz Controller.

**Available Options:** 6MHz, 8MHz , 12MHz and 16MHz

**Default setting:** 8MHz

➤ **Serial Port 1 Address**

These fields select the I/O port address for each Serial port.

**Available Options:** Disabled, 3F8H/IRQ4, 3E8H/IRQ4, 2F8H/IRQ4 and 2E8H/IRQ3.

**Default setting:** 3F8H/IRQ4

➤ **Serial Port 2 Address**

These fields select the I/O port address for each Serial port.

**Available Options:** Disabled, 3F8H/IRQ4, 3E8H/IRQ4, 2F8H/IRQ4 and 2E8H/IRQ3.

**Default setting:** 2F8H/IRQ3

■ **COMB Port Mode Selection**

These fields item can select RS-232, RS-422 and RS-485 of select COM 2.

**Available Options:** RS-232, RS-422 and RS485

**Default setting:** RS-232

➤ **Hardware Health Configuration**

On the Hardware Monitor Setup screen, you can monitor the system temperature, CPU voltage, and VBAT.

BIOS SETUP UTILITY	
Advanced	
<b>Hardware Health Configuration</b>	
H/W Health Function	[Enabled]
<b>Hardware Health Event Monitoring</b>	
SYSTEM TEMPERATURE	:43°C/109°F
EXT. TEMPERATURE	:43°C/109°F
CPU TEMPERATURE	:48°C/118°F
CPU_CORE	:0.854 V
+2.5V	:2.500 V
+3.3V	:3.306 V
+5.0V	:4.972 V
+1.8V	:1.774 V
+1.5V	:1.451 V
+1.05V	:1.000 V
VBAT	:3.258 V
Enables Hardware Health Monitoring Device.  ← Select Screen ↑↓ Select Item +- Change Option F1 General Help F10 Save and Exit ESC Exit	
v02.61 (C) Copyright 1985-2006, American Megatrends, Inc.	

➤ **APM Configuration**

You can use this screen to select options for the USB Configuration.



➤ **Power Management/APM**

Select Enabled to activate the chipset Power Management and APM (Advanced Power Management) features.

**Available Options:** Disabled and Enabled

**Default setting:** Enabled

➤ **Video Power Down Mode**

This field specifies the power conserving state that video subsystem enters after the specified period of display inactivity has expired.

**Available Options:** Disabled, Standby, Suspend

**Default setting:** Disabled

➤ **Hard Disk Power Down Mode**

This field specifies the power conserving state that the hard disk drive enters after the specified period of hard drive inactivity has expired.

**Available Options:** Disabled, Standby, Suspend

**Default setting:** Disabled

➤ **Suspend Time Out (Minute)**

This field specifies the length of a period of system inactivity (like hard disk or video) while in full power on state. When this length of time expires, the system enters Suspend power state.

**Available Options:** Disabled, 1 Minute, 2 Minute, 4 Minute, and 8 Minute, up to 60 Minute.

**Default setting:** Disabled

➤ **USB Configuration**

You can use this screen to select options for the USB Configuration.

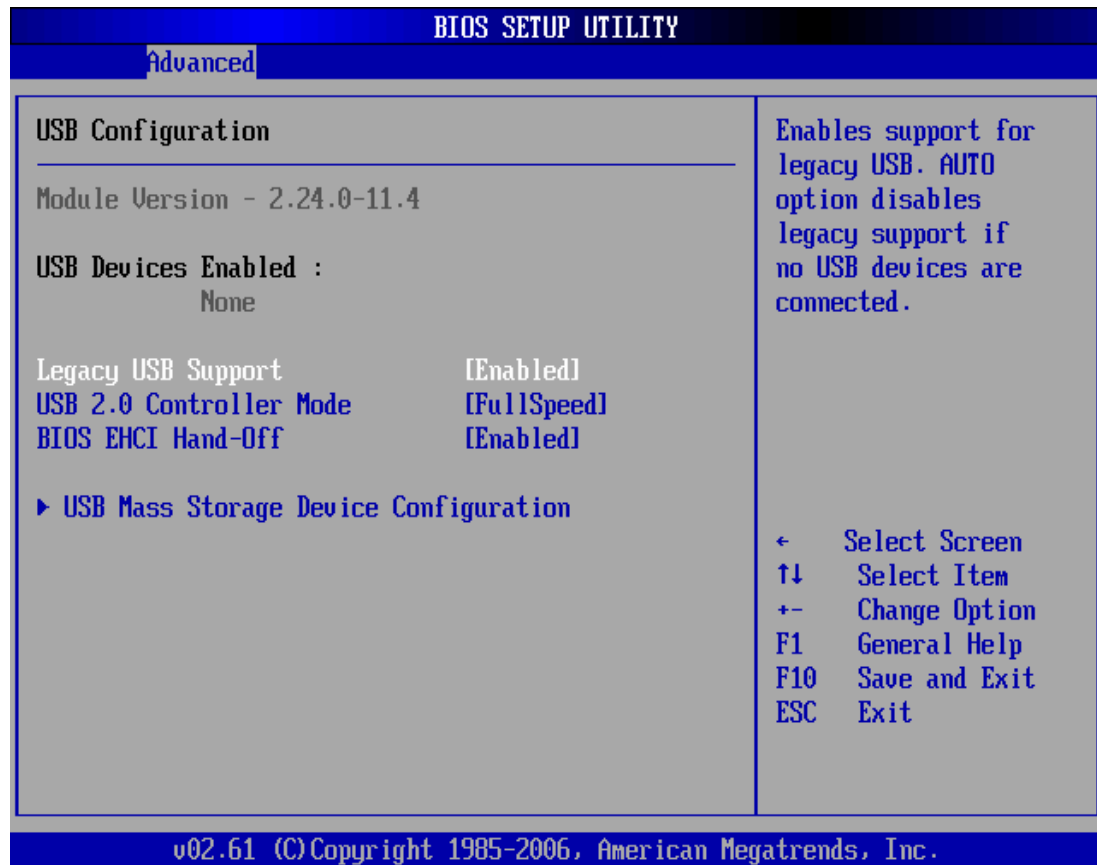

➤ **Legacy USB Support**

Legacy USB Support refers to the USB mouse and USB keyboard support. Normally if this option is not enabled, any attached USB mouse or USB keyboard will not become available until a USB compatible operating system is fully booted with all USB drivers loaded. When this option is enabled, any attached USB mouse or USB keyboard can control the system even when there is no USB drivers loaded on the system. Set this value to enable or disable the Legacy USB Support.

**Available Options:** Disabled, Enabled and AUTO

**Default setting:** Enabled

➤ **USB 2.0 Controller**

This field is Enables USB controllers. Select Enable, if a USB device is installed to the system. If Disabled are selected, the system will not be able to use a USB device.

**Available Options:** Enabled, and Disabled

**Default setting:** Enabled

➤ **USB 2.0 Controller Mode**

This field is configures the USB 2.0 controllers in High speed (480Mbps) or Full speed (12Mbps).

**Available Options:** HiSpeed and FullSpeed

**Default setting:** Hispeed

➤ **BIOS ECHI Hand-Off**

This is a workaround for OS without ECHI Hand-Off support. The ECHI ownership change should claim by ECHI driver.

**Available Options:** Enabled and Disabled

Default setting: Enabled

## PCIPnP Setup

Select the *PCI/PnP* tab from the setup screen to enter the Plug and Play BIOS Setup screen. You can display a Plug and Play BIOS Setup option by highlighting it using the <Arrow> keys. All Plug and Play BIOS Setup options are described in this section. The Plug and Play BIOS Setup screen is shown below.



➤ **Clean NVRAM**

Clean NVRAM during system boot.

**Available Options:** Yes, No

**Default setting:** No

➤ **Plug and Plug Aware O/S**

Set to Yes to inform BIOS that the operating system can handle Plug and Play (PnP) devices.

**Available Options:** Yes, No

**Default setting:** No

➤ **PCI Latency Timer**

This field specifies the latency timings (in PCI clock) PCI devices installed in the PCI expansion bus.

**Available Options:** 32, 64, 96, 128, 160,192, 224, and 248

**Default setting:** 64

➤ **Palette Snoop**

When Enabled is selected, multiple VGA devices operating on different buses can handle data from the CPU on each set of palette registers on every video device. Bit 5 of the command register in the PCI device configuration space is the VGA Palette Snoop bit. (0 is disabled).

**Available Options:**

Disabled: Data read and written by the CPU is only directed to the PCI VGA devices palette registers.

Enabled: Data read and written by the CPU is directed to both the PCI VGA devices palette registers.

**Default setting:** Disabled

➤ **PCI IDE BusMaster**

This option is to specify that the IDE controller on the PCI local bus have bus-mastering capability.

**Available Options:** Enabled, Disabled

**Default setting:** Disabled

➤ **IRQ 3 -15**

When I/O resources are controlled manually, you can assign each system interrupt as one of the following types, based on the type of device using the interrupt:

Available: Specified IRQ is available to the used by PCI/PnP devices.

Reserved: Specified IRQ is reserved for used by Legacy ISA devices.

**Available Options:** Available and Reserved

**Default setting:** Available

➤ **DMA Channel 0 – 7**

When I/O resources are controlled manually, you can assign each system DMA as one of the following types, based on the type of device using the interrupt:

Available: Specified IRQ is available to the used by PCI/PnP devices.

Reserved: Specified IRQ is reserved for used by Legacy ISA devices.

**Available Options:** Available and Reserved

**Default setting:** Available

## Boot Setup

Select the *Boot* tab from the setup screen to enter the Boot BIOS Setup screen. You can select any of the items in the left frame of the screen, such as Boot Device Priority, to go to the sub menu for that item. You can display a Boot BIOS Setup option by highlighting it using the <Arrow> keys. All Boot Setup options are described in this section. Select an item on the Boot Setup screen to access the sub menu for:

- Boot Setting Configuration
- Boot Device Priority
- Removable Drives
- Hard disk Drives
- CD/DVD Drives

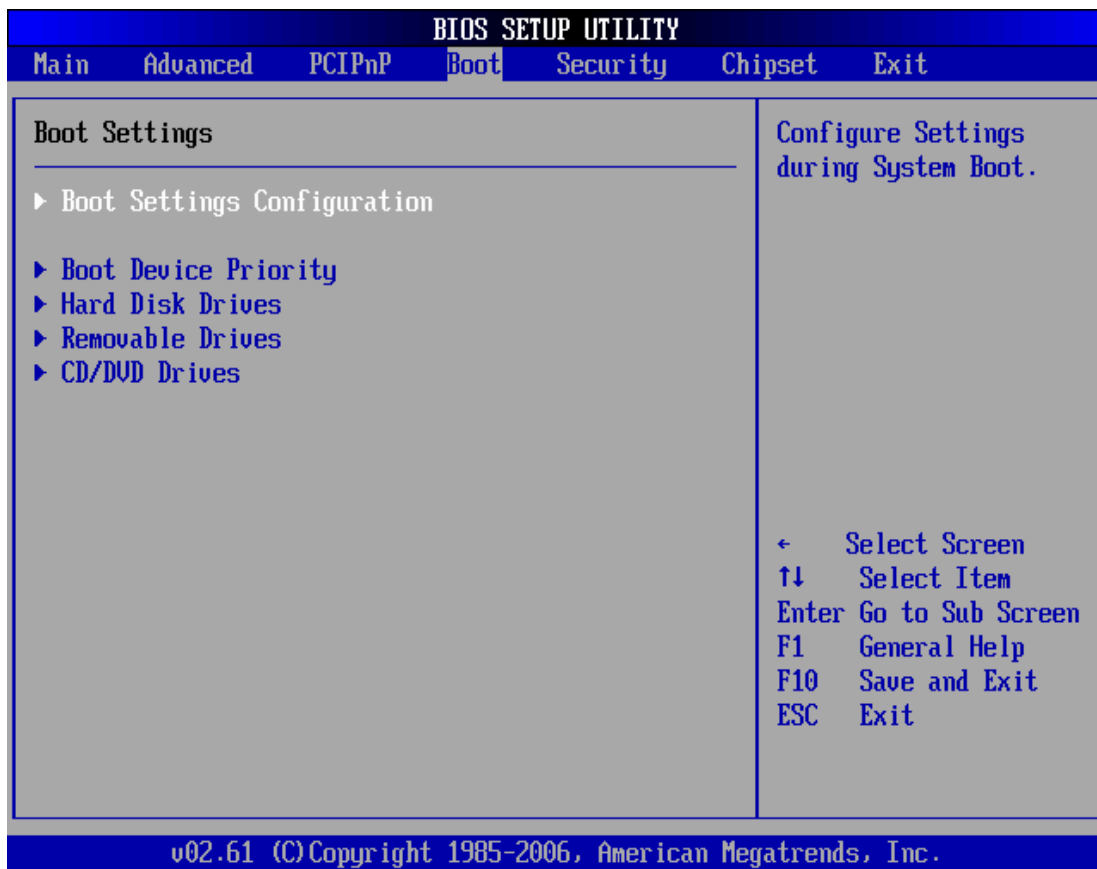

➤ **Boot Setting Configuration**

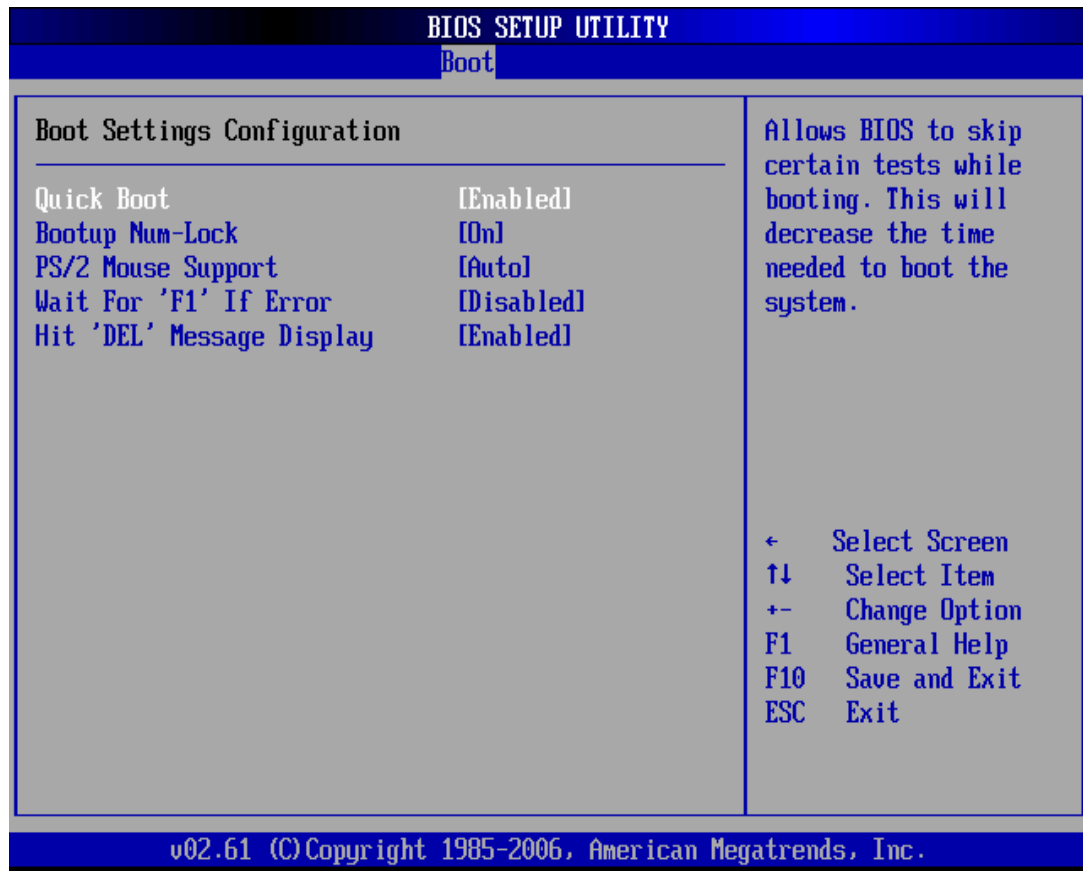

➤ **Quick Boot**

This field is used to activate the quick boot function of the system. When set to Enabled,

1. BIOS will not wait for up to 40 seconds if a Ready signal is not received from the IDE drive, and will not configure its drive.
2. BIOS will not wait for 0.5 seconds after sending a RESET signal to the IDE drive.
3. You cannot run BIOS Setup at system boot since there is no delay for the Hit, Del. To run Setup message.

**Available Options:** Disabled, Enabled

**Default setting:** Enabled

➤ **Boot Up Num-Lock**

This field is used to activate the Num Lock function upon system boot. If the setting is on, after a boot, the Num Lock light is lit, and user can use the number key.

**Available options:** On, Off

**Default setting:** On

➤ **PS/2 Mouse Support**

The PS/2 mouse function is optional. Before you configure this field, make sure your system board supports this feature. The setting of ***Enabled*** allows the system to detect a PS/2 mouse on boot up. If detected, IRQ12 will be used for the PS/2 mouse. IRQ 12 will be reserved for expansion cards if a PS/2 mouse is not detected. ***Disabled*** will reserve IRQ12 for expansion cards and therefore the PS/2 mouse will not function.

**Available options:** Disabled, Enabled and Auto

**Default setting:** Auto

➤ **Hit 'DEL' Message Display**

Set this field to ***Disabled*** to prevent the message as follows:

Hit 'DEL' if you want to run setup

It will prevent the message from appearing on the first BIOS screen when the computer boots.

**Available options:** Disabled, Enabled

**Default setting:** Enabled

➤ **Boot Device**

Use this screen to specify the order in which the system checks for the device to boot from. To access this screen, select Boot Device Priority on the Boot Setup screen and press <Enter>.

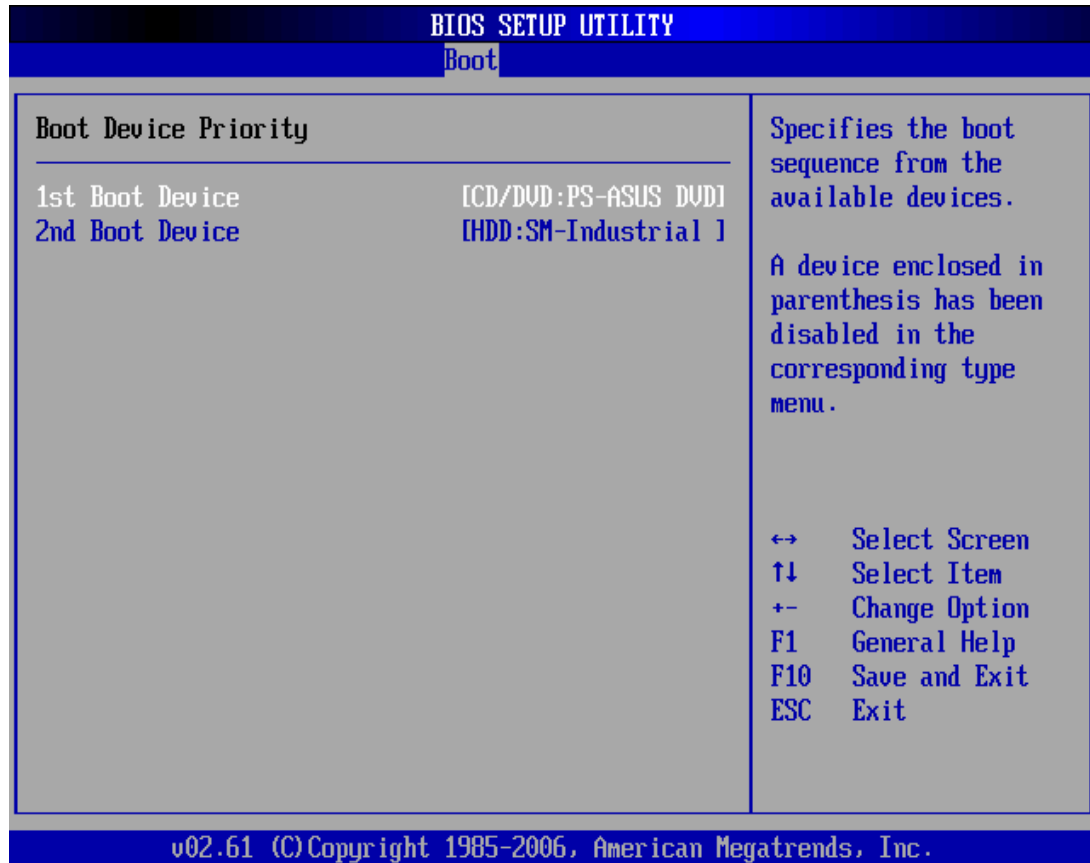

➤ **First /Second /Third Hard Disk Boot Device**

Set the boot device options to determine the sequence in which the computer checks which device to boot from. The settings are *Removable Dev.*, *Hard Drive*, or *ATAPI CDROM*.

**Note:** When you select a boot category from the boot menu, a list of devices in that category appears. For example, if the system has three hard disk drives connected, then the list will show all three hard disk drives attached

➤ **Hard Disk Drives**

Use this screen to view the hard disk drives in the system. To access this screen, select Hard disk drives on the Boot Setup screen and press <Enter>.

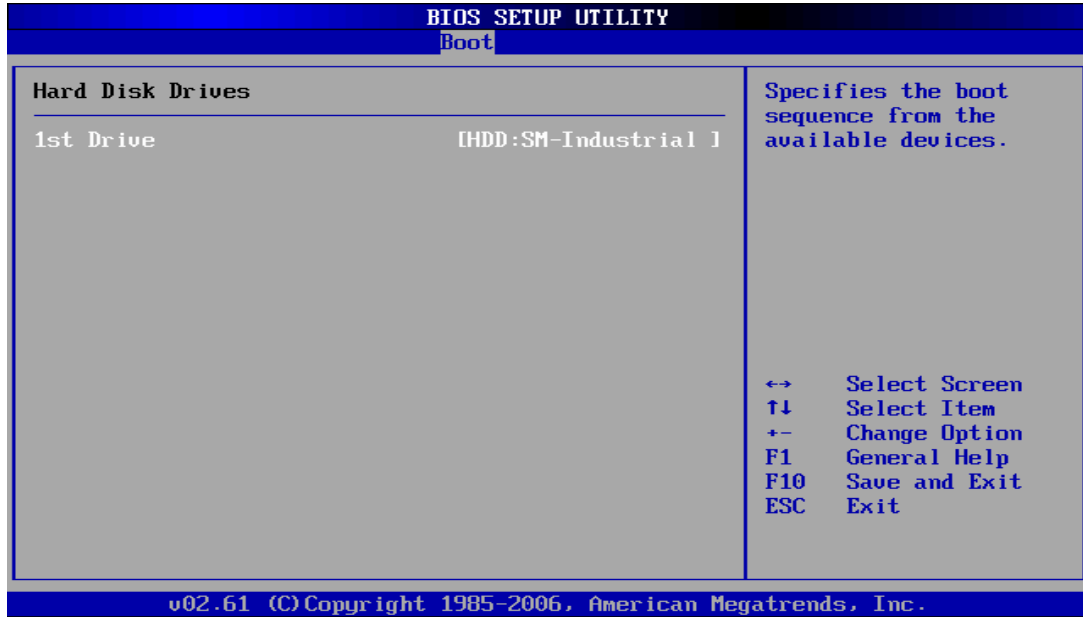

➤ **Removable Drives**

Use this screen to view the removable drives attached to the system. To access this screen, select Removable Devices on the Boot Setup screen and press <Enter>.

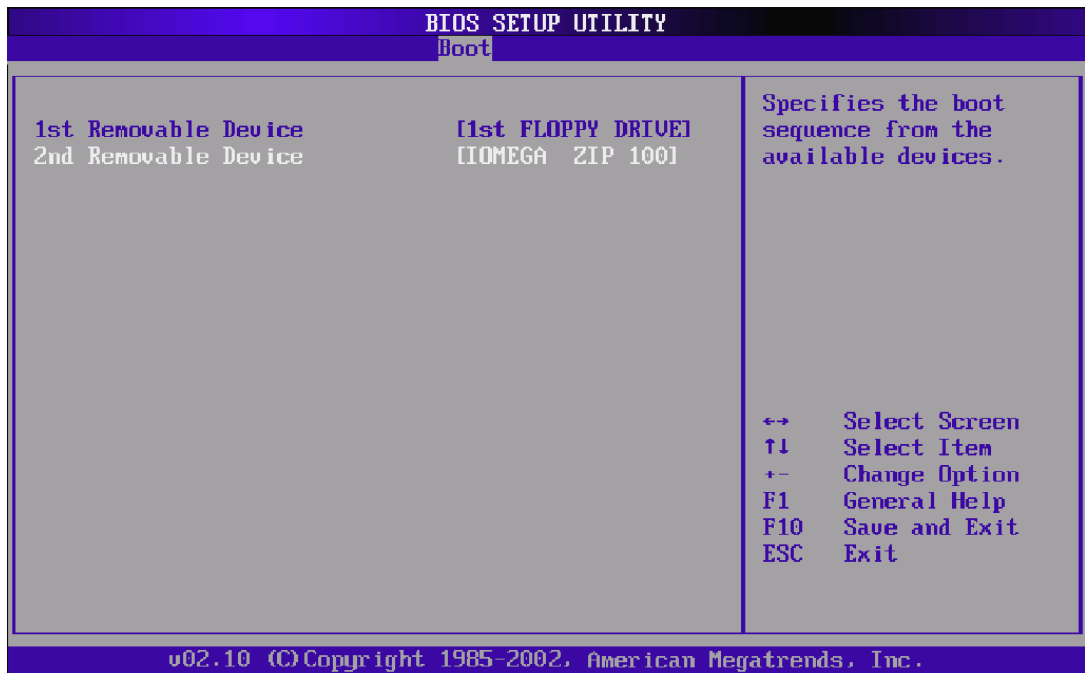

➤ **CD/DVD Disk Drives**

Use this screen to view the CD/DVD drives in the system. To access this screen, select CD/DVD drives on the Boot Setup screen and press <Enter>.

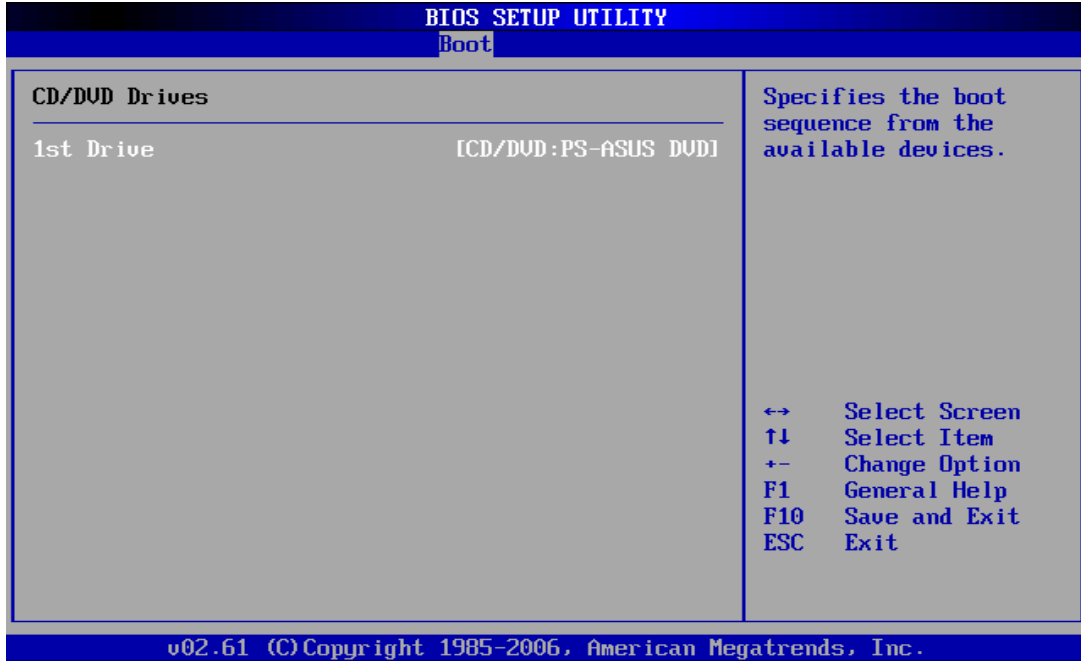

## Security setup

There are two security passwords: Supervisor and User. Supervisor is a privileged person that can change the User password from the BIOS. According to the default setting, both access passwords are not set up and are only valid after you set the password from the BIOS.

- Change Supervisor Password
- Change User Password
- Clear User Password
- Boot Sector Virus Protection



To set the password, please complete the following steps.

1. Select **Change Supervisor Password**.
2. Type the desired password (up to 6 character length) when you see the message, "Enter New Supervisor Password."
3. Then you can go on to set a user password (up to 6 character length) if required. Note that you cannot configure the User password until the Supervisor password is set up.
4. Enter Advanced BIOS Features screen and point to the Security Option field.

5. Select System or Setup.
  - ✧ **Always:** a visitor who attempts to enter BIOS or operating system will be prompted for password.
  - ✧ **Setup:** a visitor who attempts to the operating system will be prompted for user password. You can enter either User password or Supervisor password.
6. Point to **Save Settings and Exit** and press Enter.
7. Press Y when you see the message, "Save Current Settings and Exit (Y/N)?"

Note: it is suggested that you write down the password in a safe place to avoid that password may be forgotten or missing.

➤ **Clean User Password**

Select Clear User Password from the Security Setup menu and press <Enter>. Clear New Password > [Ok] [Cancel] appears. Type the password and press <Enter>. The screen does not display the characters entered. Retype the password as prompted and press <Enter>.

➤ **Password Check**

This field enables password checking every time the computer is powered on or every time the BIOS Setup is executed. If **Always** is chosen, a user password prompt appears every time and the BIOS Setup Program executes and the computer is turned on. If **Setup** is chosen, the password prompt appears if the BIOS executed.

**Available options:** Setup, Always

**Default setting:** Setup

➤ **Boot Sector Virus Protection**

This option is near the bottom of the Security Setup screen. The Optimal and Fail-Safe default setting is *Disabled*

Enabled: Set this value to prevent the Boot Sector Virus Protection. This is the default setting.

Disabled: Select Enabled to enable boot sector protection, displays a warning when any program (or virus) issues a Disk Format command or attempts to write to the boot sector of the hard disk drive. If enabled, the following appears when a write is attempted to the boot sector. You may have to type N several times to prevent the boot sector write. Boot Sector Write!

Possible VIRUS: Continue (Y/N)? \_

The following appears after any attempt to format any cylinder, head, or sector of any hard disk drive via the BIOS INT 13 Hard disk drive Service:

Format!!!

Possible VIRUS: Continue (Y/N)?

## Chipset Setup

This section describes the configuration of the board's chipset features.

- North Bridge Configuration
- South Bridge Configuration



➤ **Northbridge Configuration**

You can use this screen to select options for the North Bridge Configuration. Use the up and down <Arrow> keys to select an item. Use the <Plus> and <Minus> keys to change the value of the selected option.

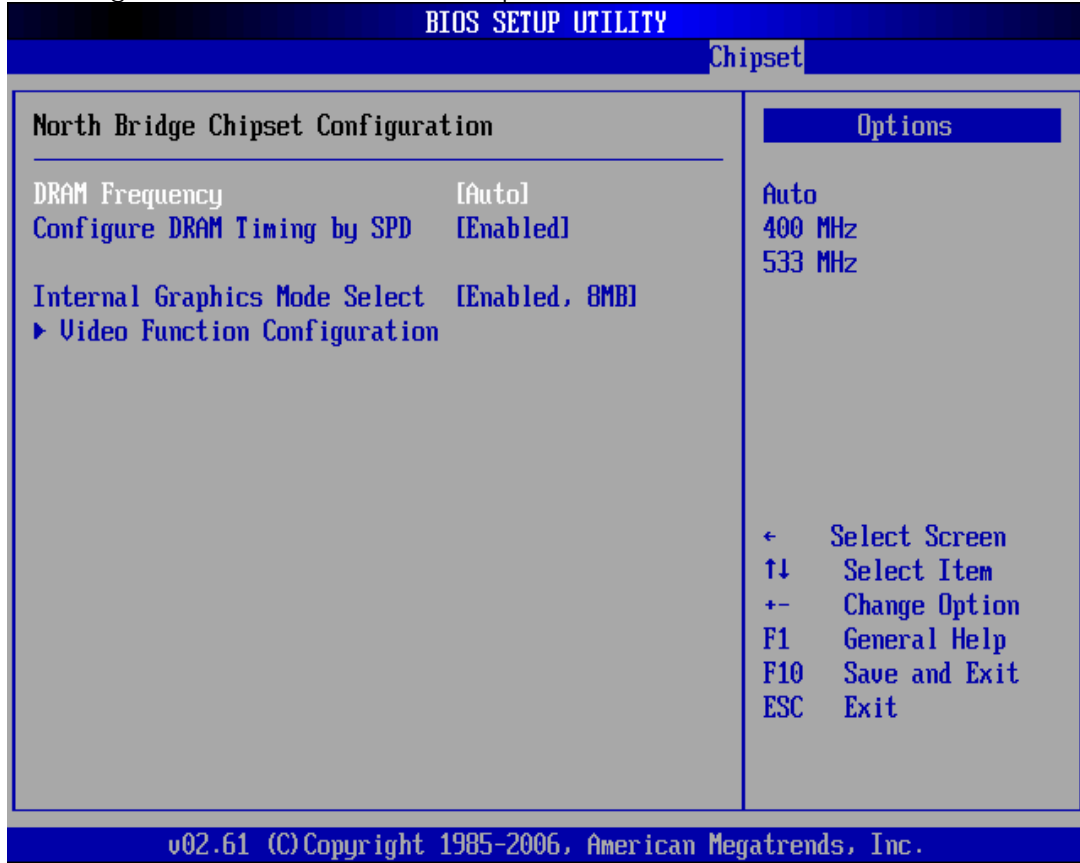

➤ **DRAM Frequency**

This specifies the SDRAM memory clock frequency.

**Available Options:** Auto, 400MHz, and 533MHz

**Default setting:** Auto

➤ **Configure DRAM Timing by SPD**

SPD represents Serial Presence Detect. It is an 8-bit, 2048 bits EEPROM, built on the SDRAM for 100 MHz frequencies. If the installed SDRAM supports SPD function, select SPD. If not, you can select based on other access time of the SDRAM.

**Available Options:** Disabled and Enabled

**Default setting:** Enabled

➤ **Internal Graphics Mode Select**

This field is share memory architecture (SMA) for frame buffer memory. SMA allows system memory to be efficiently share by the host CPU and allocated depending on user preference, application requirements, and total size of system memory.

**Available Options:** Disabled, 1MB, 4MB, 8MB, 16MB and 32MB

**Default setting:** 8MB

➤ **Graphics Aperture Size**

This field specifies the system memory size that can be used by the Accelerated Graphics Port (AGP).

**Available Options:** 64MB, 128MB and 256MB

**Default setting:** 64 MB

➤ **Video Function Configuration**

■ ***DVMT Mode Select***

This field is the *DVMT mode* is memory that is dynamically allocated based on memory requests made by application and are released back to the system once the requesting application has been terminated. *Fixed mode* is non-contiguous page locked memory allocated during driver initialization to provide a static amount of memory.

**Available Options:** Disabled, Fixed Mode, Combo Mode and DVMT Mode

**Default setting:** DVMT Mode

■ ***DVMT/FIXED Memory***

This field specifies allows you to select the maximum amount of graphics memory to be shared with the system memory.

**Available Options:** 32MB, 64MB, 128MB and Maximum DVMT

**Default setting:** DVMT Mode

■ ***Boot Display Device***

This field specifies which VGA display will be used when the system is boot. You can select either the EFP(DVI) or the CRT + LFP booting on the VGA and TV Display.

**Available Options:** CRT, EFP, TV and CRT+EFP

**Default setting:** CRT+EFP

➤ **Southbridge Configuration**

You can use this screen to select options for the South Bridge Configuration. South Bridge is a chipset on the motherboard that controls the basic I/O functions, LAN port, and audio function.

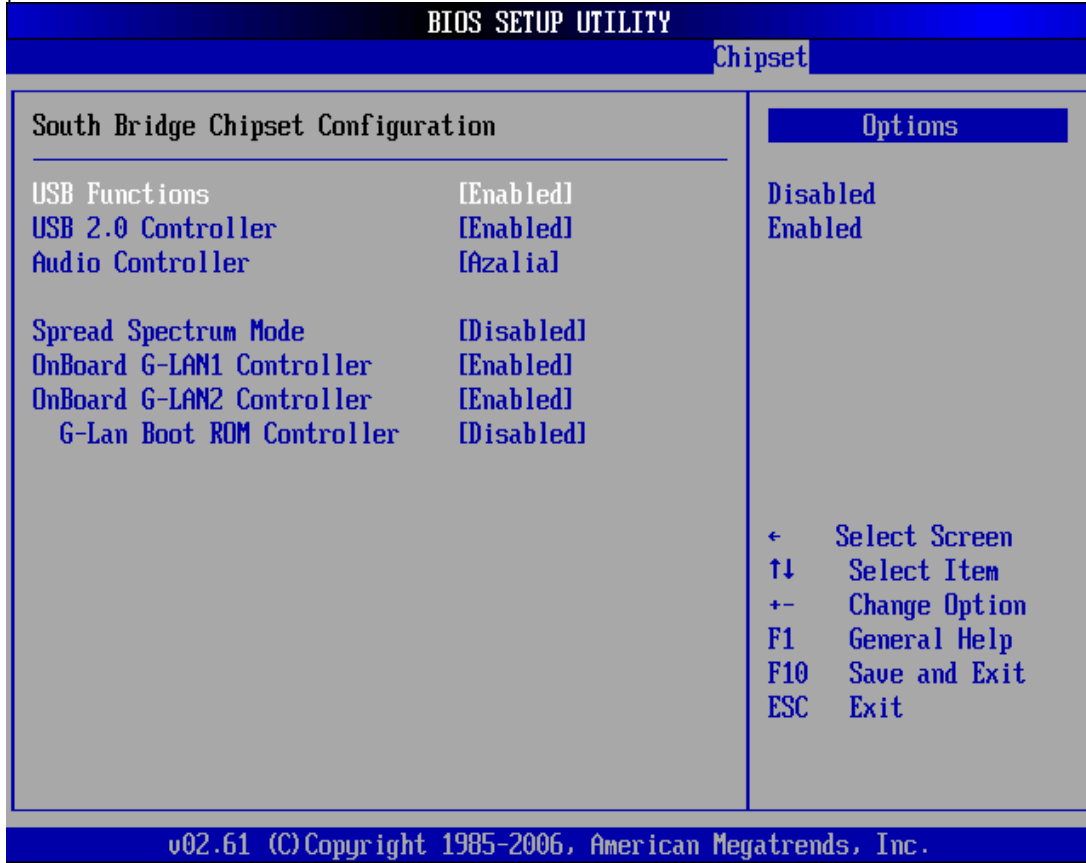

➤ **USB Function**

Select Enabled, if a USB device is installed to the system. If Disabled are selected, the system will not be able to use a USB device.

**Available Options:** Disabled, 2 USB Ports, 4 USB Ports, and 6 USB Ports

**Default setting:** 6 USB Ports

➤ **USB 2.0 Controller**

This field is select Enabled or Disabled the USB 2.0 controllers

**Available Options:** Disabled, Enabled

**Default setting:** Enabled

➤ **Audio Controller**

This field specifies the internal Audio Control.

**Available Options:** Disabled and Azalia

**Default setting:** Azalia

➤ **On Board G-LAN1/G-LAN2 Controller**

This field specifies the Enable or Disable of the onboard (Giga-1000M) LAN chip.

**Available Options:** Disabled, Enabled

**Default setting:** Enabled

➤ **G-LAN Boot ROM Controller**

This field specifies the PXE boot ROM of the onboard (Giga-1000M) LAN chip.

**Available Options:** Disabled, Enabled

**Default setting:** Disabled



## Chapter 4 Software Installation

The enclosed CD diskette includes FX5506 VGA, Audio, System, and LAN driver. To install and configure you FX5506 system, you need to perform the following steps.

### System Driver

#### WIN 2000/2003/XP/Vista-x64 Driver

Installs 945GME Chipset, IRQ Routing, USB, AGP Driver and ISA IDE Bus Master Drive.

- Step 1: To install the 945GME driver, insert the CD ROM into the CD ROM device, and enter DRIVER>SysChip>ICH7.
- Step 2: Execute Setup.exe file.
- Step 3: The screen shows the SETUP type. Press any key to enter the main menu.
- Step 4: As the setup is completed, the system will generate the message as follows.

Yes, I want to restart my computer now. Installation is done!

No, I will restart my computer later.

System must be restart then complete the installation.

**Note:** In the Syschip>ICH7 directory, a Readme.txt file is included to provide installation information.

## VGA Driver

### WIN 2000/2003/XP/Vista-x64 Driver

- Step 1: To install the VGA driver, insert the CD ROM into the CD ROM device, and enter DRIVER>VGA>945GME>WIN2K\_XP\_VISTA.
- Step 2: Execute SETUP.EXE file.
- Step 3: The screen shows the SETUP type. Press any key to enter the main menu.
- Step 4: As the setup is completed, the system will generate the message as follows.  
Yes, I want to restart my computer now. Installation is done!  
No, I will restart my computer later.  
System must be restart then complete the installation.
- Step 5: In the WINDOWS2000/XP/VISAT, you can find the <DISPLAYL> icon located in the {CONTROL PANEL} group.
- Step 6: Adjust the <Refresh Rate>, <Font size> and <Resolution>.

**Note:** In the DRIVER>VGA>945GME>WIN2K\_XP\_VISTA directory, a Readme.txt file is included to provide installation information.

## Audio Driver

### WIN 2000/2003/XP/Vista-x64 Driver

- Step 1: To install the AUDIO driver, insert the CD ROM into the CD ROM device, and enter DRIVER>AUDIO>ALC888>WIN2K&XP.
- Step 2: Execute SETUP.exe file.
- Step 3: The screen shows the SETUP type. Press any key to enter the main menu.
- Step 4: As the setup is completed, the system will generate the message as follows.

Yes, I want to restart my computer now. Installation is done!

No, I will restart my computer later.

System must be restart then complete the installation.

**Note:** In the DRIVER>AUDIO>ALC888>WIN2K&XP directory, a Readme.txt file is included to provide installation information.

## LAN Driver (Intel 82573L)

### WIN 2000/2003/XP/Vista-x64 Driver

Step 1: To install the LAN driver, insert the CD ROM into the CD ROM device, and enter DRIVER>LAN>82573L. If your system is not equipped with a CD ROM device, copy the LAN driver from the CD ROM to CF.

Step 2: Execute 82573L.exe or PROVISTAX64.exe file.

**Note:** In the LAN>82573L directory, has supports Windows 2K/XP and Vista – X64 LAN driver.

## BIOS Flash Utility

In the <UTILITY> directory, there is the Afu409.EXE file.

Step 1: Use the Afu409.EXE program to update the BIOS setting.

Step 2: And then refer to the chapter "BIOS Setup", as the steps to modify BIOS.

Step 3: Now the CPU board's BIOS loaded with are the newest program; user can use it to modify BIOS function in the future, when the BIOS add some functions.

## Watchdog Timer

This section describes how to use the Watchdog Timer, including disabled, enabled, and trigger functions.

The system is equipped with a programmable time-out period watchdog timer. You can use your own program to enable the watchdog timer. Once you have enabled the watchdog timer, the program should trigger the I/O every time before the timer times out. If your program fails to trigger or disable this timer before it times out, e.g. because of a system hang-up, it will generate a reset signal to reset the system. The time-out period can be programmed to be set from 1 to 255 seconds or minutes.

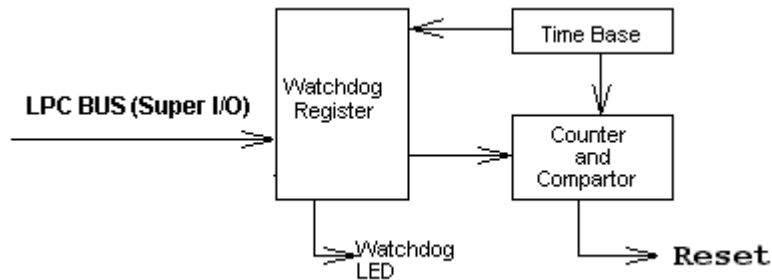

### Watchdog Timer Setting

The watchdog timer is a circuit that may be used from your program software to detect system crashes or hang-ups. The watchdog timer is automatically disabled after reset.

Once you have enabled the watchdog timer, your program must trigger the watchdog timer every time before it times out. After you trigger the watchdog timer, it will be set to non-zero value to watchdog counter and start to count down again. If your program fails to trigger the watchdog timer before time-out, it will generate a reset pulse to reset the system.

The factor of the watchdog timer time-out constant is approximately 1 second. The period for the watchdog timer time-out is between 1 to FF timer factors.

If you want to reset your system when watchdog times out, the following table listed the relation of timer factors between time-out periods.

Time Factor	Time-Out Period (Seconds)	Time-Out Period (Minutes)
1	1	1
2	2	2
3	3	3
4	4	4
5	5	5
"	"	"
"	"	"
"	"	"
FF	FF	FF

### Watchdog Timer Enabled

To enable the watchdog timer, you have to output a byte of timer factor to the watchdog register whose address is 2Eh and data port is 2fH. The following is an Assemble program, which demonstrates how to enable the watchdog timer and set the time-out period at 28 seconds.

```
-----  
; Enter the extended function mode, interruptible double-write  
-----  
Mov    dx, 2eh      ; Enter to extended function mode  
Mov    al, 87h  
Out    dx, al  
Out    dx, al  
Mov    al, 07h  
Out    dx, al  
-----  
; Logical device 8, configuration register CRF5 Bit 3, CRF6 Bit 0~7  
-----  
Mov    dx, 2fh  
Mov    al, 08h      ; Select Logical Device 8 of watchdog timer  
Out    dx, al  
Mov    dx, 2eh  
Mov    al, 0f5h     ; Set second as counting unit  
Out    dx, al  
Mov    dx, 2fh  
In     al, dx  
Or     al, c0       ; Trigger P/W LED.  
And    al, not c8h  ; Set Second.  
; And    al, c8h    ; Set Minute.  
Out    dx, al  
Mov    dx, 2eh  
Mov    al, 0f6h  
Out    dx, al  
Mov    dx, 2fh  
Mov    al, 28h     ; Set timeout interval as 28seconds and start counting  
Out    dx, al  
-----  
; Exit extended function mode  
-----  
Mov    dx, 2eh  
Mov    al, 0aah  
Out    dx, al
```

### Watchdog Timer Trigger

After you enable the watchdog timer, your program must write the same factor as enabling to the watchdog register at least once every time-out period to its previous setting. You can change the time-out period by writing another timer factor to the watchdog register at any time, and you must trigger the watchdog before the new time-out period in next trigger.

### Watchdog Timer Disabled

To disable the watchdog timer, simply write a 00H to the watchdog register.

```
-----  
; Enter the extended function mode, interruptible double-write  
-----  
Mov    dx,2eh      ; Enter to extended function mode  
Mov    al,87h  
Out    dx,al  
Out    dx,al  
-----  
; Logical device 8, configuration register CRF5 Bit 3(Sec./Min.), CRF6 Bit 0~7 (Count.)  
-----  
Mov    al,07h  
Out    dx,al  
Mov    dx,2fh  
Mov    al,08h      ; Select Logical Device 8 of watchdog timer  
Out    dx,al  
Mov    dx,2eh  
Mov    al,0f5h     ;Set second as counting unit  
Out    dx,al  
Mov    dx,2fh  
In     al,dx  
And    al,not c8h  ;Set Second or Minute.  
Out    dx,al  
Mov    dx,2eh  
Mov    al,0f6h  
Out    dx,al  
Mov    dx,2fh  
Mov    al,00h     ; Set Watchdog Timer Disabled  
Out    dx,al  
-----  
; Exit extended function mode  
-----  
Mov    dx,2eh     ;Exit the extended function mode  
Mov    al,0aah  
Out    dx,al
```

## Programming RS-485

The majority communicative operation of the RS-485 is in the same of the RS-232. When the RS-485 precedes the transmission, which needs control the TXC signal, and the installing, steps are as follows:

Step 1: Enable TXC

Step 2: Send out data

Step 3: Waiting for data empty

Step 4: Disable TXC

Note: Please refer to the section of the "Serial Ports" in the Chapter 5 "Technical Reference" for the detail description of the COM port's register.

### Initialize COM port

Step 1: Initialize COM port in the receiver interrupt mode, and /or transmitter interrupt mode. (All of the communication protocol buses of the RS-485 are in the same.)

Step 2: Disable TXC (transmitter control), the bit 0 of the address of offset+4 just sets "0".

NOTE: Control the FX5506 system "DTR" signal to the RS-485 TXC communication.

### **Send out one character (Transmit)**

Step 1: Enabled TXC signal, and the bit 0 of the address of offset+4 just sets "1".

Step 2: Send out the data. (Write this character to the offset+0 of the current COM port address)

Step 3: Wait for the buffer's data empty. Check transmitter holding register (THRE, bit 5 of the address of offset+5), and transmitter shift register (TSRE, bit 6 of the address of offset+5) are all sets must be "0".

Step 4: Disabled TXC signal, and the bit 0 of the address of offset+4 sets "0"

### **Send out one block data (Transmit – the data more than two characters)**

Step 1: Enabled TXC signal, and the bit 0 of the address of offset+4 just sets "1".

Step 2: Send out the data. (Write all data to the offset+0 of the current COM port address)

Step 3: Wait for the buffer's data empty. Check transmitter holding register (THRE, bit 5 of the address of offset+5), and transmitter shift register (TSRE, bit 6 of the address of offset+5) are all sets must be "0".

Step 4: Disabled TXC signal, and the bit 0 of the address of offset+4 sets "0"

### **Receive data**

The RS-485's operation of receiving data is in the same of the RS-232's.

### **Basic Language Example**

#### **a. Initial 86C450 UART**

```
10      OPEN "COM1:9600,m,8,1" AS #1 LEN=1
20      REM Reset DTR
30      OUT &H3FC, (INP(%H3FC) AND &HFA)
```

40        RETURN

**b. Send out one character to COM1**

```
10        REM Enabled transmitter by setting DTR ON
20        OUT &H3FC, (INP(&H3FC) OR &H01)
30        REM Send out one character
40        PRINT #1, OUTCHR$
50        REM Check transmitter holding register and shift register
60        IF ((INP(&H3FD) AND &H60) >0) THEN 60
70        REM Disabled transmitter by resetting DTR
80        OUT &H3FC, (INP(&H3FC) AND &HEF)
90        RETURN
```

**c. Receive one character from COM1**

```
10        REM Check COM1: receiver buffer
20        IF LOF(1)<256 THEN 70
30        REM Receiver buffer is empty
40        INPSTR$=""
50        RETURN
60        REM Read one character from COM1: buffer
70        INPSTR$=INPUT$(1,#1)
80        RETURN
```

**NOTE:** The RS-485 of the FX5506 uses COM2. If you want to program it and hardware setup, please refer to the BIOS Setup for COM2 address setup and Chapter 2 "Hardware Installation": Jumper Setting.

## Chapter 5 Technical Reference

This section outlines the errors that may occur when you operate the system, and also gives you the suggestions on solving the problems.

Topic include:

- Trouble Shooting for Post Beep & Error Messages
- Technical Reference

### Trouble Shooting for Post Beep and Error Messages

The following information informs the Post Beep & error messages. Please adjust your systems according to the messages below. Make sure all the components and connectors are in proper position and firmly attached. If the errors still exist, please contact with your distributor for maintenance.

#### ➤ **POST BEEP**

Currently there are two kinds of beep codes in BIOS setup.

- One indicates that a video error has occurred and the BIOS cannot initialize the video screen to display any additional information. This beep code consists of a single long beep followed by three short beeps.
- The other indicates that an error has occurred in your DRAM. This beep code consists of a constant single long beep.

#### ➤ **CMOS BATTERY FAILURE**

When the CMOS battery is out of work or has run out, the user has to replace it with a new battery.

➤ **CMOS CHECKSUM ERROR**

This error informs that the CMOS has corrupted. When the battery runs weak, this situation might happen. Please check the battery and change a new one when necessary.

➤ **DISK BOOT FAILURE**

When you can't find the boot device, insert a system disk into Drive A and press < Enter >. Make sure both the controller and cables are all in proper positions, and also make sure the disk is formatted. Then reboot the system.

➤ **DISKETTE DRIVES OR TYPES MISMATCH ERROR**

When the diskette drive type is different from CMOS, please run setup or configure the drive again.

➤ **ERROR ENCOUNTERED INITIALIZING HARD DRIVE**

When you can't initialize the hard drive, ensure the following things:

1. The adapter is installed correctly
2. All cables are correctly and firmly attached
3. The correct hard drive type is selected in BIOS Setup

➤ **ERROR INITIALIZING HARD DISK CONTROLLER**

When this error occurs, ensure the following things:

1. The cord is exactly installed in the bus.
2. The correct hard drive type is selected in BIOS Setup
3. Whether all of the jumpers are set correctly in the hard drive

➤ **FLOPPY DISK CONTROLLER ERROR OR NO CONTROLLER PRESENT**

When you cannot find or initialize the floppy drive controller, please ensure the controller is in proper BIOS Setup. If there is no floppy drive installed, ensure the Diskette Drive selection in Setup is set to NONE.

➤ **KEYBOARD ERROR OR NO KEYBOARD PRESENT**

When this situation happens, please check keyboard attachment and no keys being pressed during the boot. If you are purposely configuring the system without a keyboard, set the error halt condition in BIOS Setup to HALT ON ALL, BUT KEYBOARD. This will cause the BIOS to ignore the missing keyboard and continue the boot procedure.

➤ **MEMORY ADDRESS ERROR**

When the memory address indicates error, you can use this location along with the memory map for your system to find and replace the bad memory chips.

➤ **MEMORY SIZE HAS CHANGED**

Memory has been added or removed since last boot. In EISA mode, use Configuration Utility to re-configure the memory configuration. In ISA mode enter BIOS Setup and enter the new memory size in the memory fields.

➤ **MEMORY VERIFYING ERROR**

It indicates an error verifying a value is already written to memory. Use the location along with your system's memory map to locate the bad chip.

➤ **OFFENDING ADDRESS MISSING**

This message is used in connection with the I/O CHANNEL CHECK and RAM PARITY ERROR messages when the segment that has caused the problem cannot be isolated.

➤ **REBOOT ERROR**

When this error occurs that requires you to reboot. Press any key and the system will reboot.

➤ **SYSTEM HALTED**

Indicates the present boot attempt has been aborted and the system must be rebooted. Press and hold down the CTRL and ALT keys and press DEL.

## Technical Reference

### Physical and Environmental

Temperature: Operating 0°C ~ 50°C

Relative humidity 5 % to 95 % non-condensing

DC-AC adapter

Input AC Voltage Range: 100V~240V/1A, 50Hz ~60Hz

Output DC Voltage: 19V/3.42A Maximal

Surface Temperature of Chassis :

5°C to 45°C (W/HDD)/0°C to 50°C (W/CF card only)

### Real-Time Clock and Non-Volatile RAM

The FX5506 contains a real-time clock compartment that maintains the date and time in addition to storing configuration information about the computer system. It contains 14 bytes of clock and control registers and 114 bytes of general purpose RAM. Because of the use of CMOS technology, it consumes very little power and can be maintained for long periods of time using an internal Lithium battery. The contents of each byte in the CMOS RAM are listed below:

Address	Description
00	Seconds
01	Second alarm
02	Minutes
03	Minute alarm
04	Hours
05	Hour alarm
06	Day of week
07	Date of month
08	Month
09	Year
0A	Status register A
0B	Status register B

Address	Description
0C	Status register C
0D	Status register D
0E	Diagnostic status byte
0F	Shutdown status byte
10	Diskette drive type byte, drive A and B
11	Fixed disk type byte, drive C
12	Fixed disk type byte, drive D
13	Reserved
14	Equipment byte
15	Low base memory byte
16	High base memory byte
17	Low expansion memory byte
18	High expansion memory byte
19-2D	Reserved
2E-2F	2-byte CMOS checksum
30	Low actual expansion memory byte
31	High actual expansion memory byte
32	Date century byte
33	Information flags (set during power on)
34-7F	Reserved for system BIOS

### CMOS RAM Map

Register	Description
00h -10h	Standard AT-compatible RTC and Status and Status Register data definitions
11h – 13h	Varies
14h	<p>Equipment</p> <p>Bits 7-6 Number of Floppy Drives            00 1 Drive            01 2 Drives</p> <p>Bits 5-4 Monitor Type            00 Not CGA or MDA 01 40x25 CGA            01 2 Drives 80x25 CGA</p> <p>Bits 3 Display Enabled            0 Disabled            1 Enabled</p> <p>Bit 2 Keyboard Enabled            00 Not CGA or MDA 01 40x25 CGA            01 2 Drives 80x25 CGA</p> <p>Bit 1 Math Coprocessor Installed            0 Absent            1 Present</p> <p>Bit 0 Floppy Drive Installed            0 Disabled            1 Enabled</p>
15h	Base Memory (in 1KB increments), Low Byte
16h	Base Memory (in 1KB increments), High Byte
17h	IBM-compatible memory (in 1KB increments), Low Byte
18h	IBM-compatible memory (in 1KB increments), High Byte (max 15 MB)
19h-2Dh	Varies
2Eh	Standard CMOS RAM checksum, high byte
2Fh	Standard CMOS RAM checksum, low byte
30h	IBM-compatible Extended Memory, Low Byte (POST) in KB
31h	IBM-compatible Extended Memory, High Byte (POST) in KB
32h	Century Byte
33h	Reserved. Do not use
34h	Reserved. Do not use
35h	Low byte of extended memory (POST) in 64 KB
36h	High byte of extended memory (POST) in 64 KB
37h-3Dh	Varies
3Eh	Extended CMOS Checksum, Low Byte (including 34h-3Dh)
3Fh	Extended CMOS Checksum, High Byte (including 34h-3Dh)

### I/O Port Address Map

Each peripheral device in the system is assigned a set of I/O port addresses, which also becomes the identity of the device. There is a total of 1K-port address space available. The following table lists the I/O port addresses used on the Industrial CPU Card.

Address	Device Description
000h - 01Fh	DMA Controller #1
020h - 03Fh	Interrupt Controller #1
040h - 05Fh	Timer
060h - 06Fh	Keyboard Controller
070h - 071h	Real Time Clock, NMI
080h - 09Fh	DMA Page Register
0A0h - 0BFh	Interrupt Controller #2
0C0h - 0DFh	DMA Controller #2
0F0h	Clear Math Coprocessor Busy Signal
0F1h	Reset Math Coprocessor
1F0h - 1F7h	IDE Interface
2E8h - 2EFh	Serial Port #4(COM4)
2F8h - 2FFh	Serial Port #2(COM2)
2B0 - 2DF	Graphics adapter Controller
3B0 - 3BF	Monochrome & Printer adapter
3C0 - 3CF	EGA adapter
3D0 - 3DF	CGA adapter
3E8h - 3EFh	Serial Port #3(COM3)
3F8h - 3FFh	Serial Port #1(COM1)

### Interrupt Request Lines (IRQ)

There are a total of 15 IRQ lines available on the Industrial CPU Card. Peripheral devices use interrupt request lines to notify CPU for the service required. The following table shows the IRQ used by the devices on the Industrial CPU Card.

Level	Function
IRQ0	System Timer Output
IRQ1	Keyboard
IRQ2	Interrupt Cascade
IRQ3	Serial Port #2
IRQ4	Serial Port #1
IRQ5	USB#0
IRQ6	-
IRQ7	LAN2
IRQ8	Real Time Clock
IRQ9	SM-BUS
IRQ10	USB#1
IRQ11	USB#2/LAN1/VGA
IRQ12	USB#3/PS2 Mouse
IRQ13	FPU
IRQ14	Primary IDE (CF)
IRQ15	-

### DMA Channel Map

The equivalents of two 8237A DMA controllers are implemented in the FX5506 board. Each controller is a four-channel DMA device that will generate the memory addresses and control signals necessary to transfer information directly between a peripheral device and memory. This allows high speed information transfer with less CPU intervention. The two DMA controllers are internally cascaded to provide four DMA channels for transfers to 8-bit peripherals (DMA1) and three channels for transfers to 16-bit peripherals (DMA2). DMA2 channel 0 provides the cascade interconnection between the two DMA devices, thereby maintaining IBM PC/AT compatibility.

The following is the system information of DMA channels:

DMA Controller 1	DMA Controller 2
Channel 0: Spare	Channel 4: Cascade for controller 1
Channel 1: Reserved for IBM SDLC	Channel 5: Spare
Channel 2: Diskette adapter	Channel 6: Spare
Channel 3: Spare	Channel 7: Spare

## Serial Ports

The ACEs (Asynchronous Communication Elements ACE1 to ACE2) are used to convert parallel data to a serial format on the transmit side and convert serial data to parallel on the receiver side. The serial format, in order of transmission and reception, is a start bit, followed by five to eight data bits, a parity bit (if programmed) and one, one and half (five-bit format only) or two stop bits. The ACEs are capable of handling divisors of 1 to 65535, and produce a 16x clock for driving the internal transmitter logic.

Provisions are also included to use this 16x clock to drive the receiver logic, also included in the ACE a completed MODEM control capability, and a processor interrupt system that may be software tailored to the computing time required to handle the communications link.

The following table is a summary of each ACE accessible register

DLAB	Port Address	Register
0	Base + 0	Receiver buffer (read)
		Transmitter holding register (write)
0	Base + 1	Interrupt enable
X	Base + 2	Interrupt identification (read only)
X	Base + 3	Line control
X	Base + 4	MODEM control
X	Base + 5	Line status
X	Base + 6	MODEM status
X	Base + 7	Scratched register
1	Base + 0	Divisor latch (least significant byte)
1	Base + 1	Divisor latch (most significant byte)

➤ **Receiver Buffer Register (RBR)**

Bit 0-7: Received data byte (Read Only)

➤ **Transmitter Holding Register (THR)**

Bit 0-7: Transmitter holding data byte (Write Only)

➤ **Interrupt Enable Register (IER)**

Bit 0: Enable Received Data Available Interrupt (ERBFI)

Bit 1: Enable Transmitter Holding Empty Interrupt (ETBEI)

Bit 2: Enable Receiver Line Status Interrupt (ELSI)

Bit 3: Enable MODEM Status Interrupt (EDSSI)

Bit 4: Must be 0

Bit 5: Must be 0

Bit 6: Must be 0

Bit 7: Must be 0

➤ **Interrupt Identification Register (IIR)**

Bit 0: "0" if Interrupt Pending

Bit 1: Interrupt ID Bit 0

Bit 2: Interrupt ID Bit 1

Bit 3: Must be 0

Bit 4: Must be 0

Bit 5: Must be 0

Bit 6: Must be 0

Bit 7: Must be 0

➤ **Line Control Register (LCR)**

Bit 0: Word Length Select Bit 0 (WLS0)

Bit 1: Word Length Select Bit 1 (WLS1)

WLS1	WLS0	Word Length
0	0	5 Bits
0	1	6 Bits
1	0	7 Bits
1	1	8 Bits

Bit 2: Number of Stop Bit (STB)

Bit 3: Parity Enable (PEN)

Bit 4: Even Parity Select (EPS)

Bit 5: Stick Parity

Bit 6: Set Break

Bit 7: Divisor Latch Access Bit (DLAB)

➤ **MODEM Control Register (MCR)**

Bit 0: Data Terminal Ready (DTR)

Bit 1: Request to Send (RTS)

Bit 2: Out 1 (OUT 1)

Bit 3: Out 2 (OUT 2)

Bit 4: Loop

Bit 5: Must be 0

Bit 6: Must be 0

Bit 7: Must be 0

➤ **Line Status Register (LSR)**

Bit 0: Data Ready (DR)

Bit 1: Overrun Error (OR)

Bit 2: Parity Error (PE)

Bit 3: Framing Error (FE)

Bit 4: Break Interrupt (BI)

Bit 5: Transmitter Holding Register Empty (THRE)

Bit 6: Transmitter Shift Register Empty (TSRE)

Bit 7: Must be 0

➤ **MODEM Status Register (MSR)**

Bit 0: Delta Clear to Send (DCTS)

Bit 1: Delta Data Set Ready (DDSR)

Bit 2: Training Edge Ring Indicator (TERI)

Bit 3: Delta Receive Line Signal Detect (DSLSD)

Bit 4: Clear to Send (CTS)

Bit 5: Data Set Ready (DSR)

Bit 6: Ring Indicator (RI)

Bit 7: Received Line Signal Detect (RSLD)

➤ **Divisor Latch (LS, MS)**

	LS	MS
Bit 0:	Bit 0	Bit 8
Bit 1:	Bit 1	Bit 9
Bit 2:	Bit 2	Bit 10
Bit 3:	Bit 3	Bit 11
Bit 4:	Bit 4	Bit 12
Bit 5:	Bit 5	Bit 13
Bit 6:	Bit 6	Bit 14
Bit 7:	Bit 7	Bit 15

Desired Baud Rate	Divisor Used to Generate 16x Clock
300	384
600	192
1200	96
1800	64
2400	48
3600	32
4800	24
9600	12
14400	8
19200	6
28800	4
38400	3
57600	2
115200	1

## Appendix

### Dimension

a. FX5506

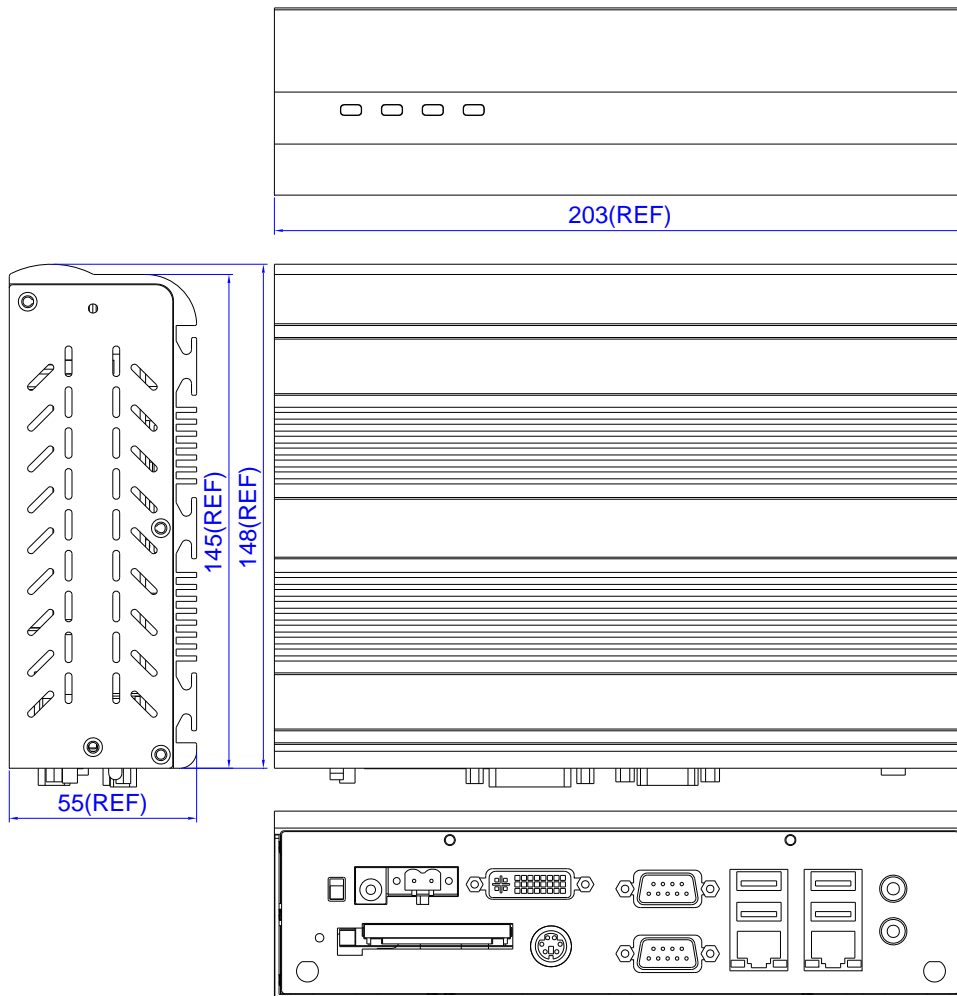

b. FX5501K1 universal fixers

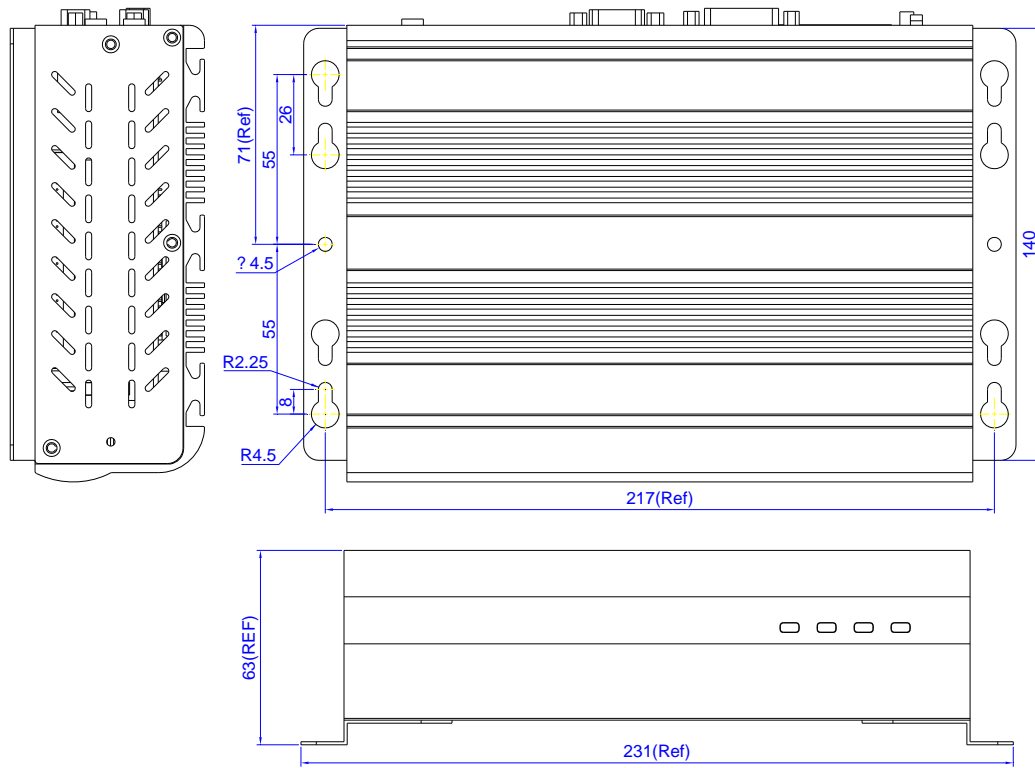

c. FX5501K2 universal fixers

